



Acoustic and Play

Richter Spielgeräte GmbH



Acoustic and Play

Richter Spielgeräte GmbH has been designing play areas for over 50 years. What is especially important to us is that our equipment promotes the conscious use of our senses.

This theme catalogue offers comprehensive information on the subject of "acoustic effects" and "hearing". Children in particular very much enjoy creating sounds generated by movements they can make themselves. For older people, hearing represents a very special way of connecting to their environment.

The concept "hearing – listening – belonging" makes it clear that the ear, like no other organ, ensures a sense of belonging.

Frasdorf, August 2021

Richter Spielgeräte GmbH

Simsseestraße 29

83 112 Frasdorf

Germany

Phone + 49 - 80 52 - 1 79 80

Fax + 49 - 80 52 - 41 80

www.richter-spielgeraete.de

info@richter-spielgeraete.de

Photos:

© Daniel Perales

© Ayumi Nakanishi

© Anton Donikov

Contents

Information about

Planning

Quality criteria

In the Playground ...

Page 7	Sound Cushions
9	Wind Pipes
11	Sound Roller
13	Wind Pumps
15	Sea Roarer · Piper
17	Phones
19	Ear and Speaking Trumpet
21	Parabolic Reflectors
23	Dance Chimes
25	Instrument · Sound Wall
27	Ferraphone
29	Kling Klang Disc

... and „everywhere“

Page 33	Impulse Spheres
35	Small Singing Stone
37	Large Singing Stone
39	Tuning Stone
41	Stone Harp
43	Stone Xylophone
45	Triangles
47	Gong
49	Metal Gongs
51	Sound Chord
53	Tubular Chimes
55	Wind Harp
57	Dendrophone
59	Tubular-Dendrophone
61	Sound Arch
63	Sound Leaf · Sound Tree · Steeldrum
65	Listening to Water
67	Melodic Fence
69	Conference
71	Echo Game

Planning Information

Creating environmental structures for people places high demands on planners, amongst others.

Although equipment with acoustic effects may be very interesting for this, even greater care is required for the planning than might be the case for non-acoustic equipment. The reason for this is that the effect can be extremely versatile, ranging from simple noise to tuned harmonies, from loud to soft, from high to low.

Children have great fun triggering acoustic effects through physical activities, for example. In the process, their main concern is not how harmonious, pleasant or even disturbing these sound effects might be to other people. Being used to normal playground equipment, it is also not important to them that sound equipment is often more prone to damage than what they are used to.

This means that not every type of equipment is suitable for every play space. Regardless of the question of need, factors such as vulnerability to wilful destruction or disturbance by noise can have an influence on where it can be used.

To avoid any unpleasant surprises, we have therefore carried out a rough assessment of all equipment with acoustic effects in terms of noise levels and susceptibility to vandalism.

The assessment of the acoustic effects is based on the following three levels:

- strong,
- medium,
- soft.

Notes that are loud, high, hard or shrill are considered to be more annoying than deep, quiet, soft and gentle notes, which are perceived as pleasant.

For assessing vulnerability to vandalism we have chosen the following terms:

- vulnerable (like a musical instrument),
- slightly vulnerable (depending on location, particularly in areas that are obscured from view),
- not vulnerable (comparable to playground stability).

Some things that we adults perceive as destruction, children simply consider a part of play and often take place without the intention of destroying anything.

The numerous options to combine our acoustic devices open up wonderful and unique spaces of wellbeing through the creation of clouds of sound.

Immanuel Kant was quoted as saying: "Not seeing separates us from things, not hearing separates us from people".

Explanation of following icons



Videos

You can find videos on our website for the equipment marked with this icon.



Young People

The equipment marked with this icon is also especially suited for young people.



Inclusion

The equipment marked with this symbol is barrier-free accessible and especially suitable for integrative playspaces.

The FSC® certified paper Gardapat 13 Kiara was used for this catalogue.



Licensor and designer:

G. Beltzig, F. Dorband / K.H. Thiele, J. Faßbender, W. Graubner, M. Kachel, A. van Leggelo, J. Weber

Quality Criteria

For additional explanations of the quality criteria please refer to our price list.



Peeled white

Palisades peeled white means that bark, cambium and sapwood are removed, the natural shape of the trunk is preserved and can be experienced



Bevel cut

Vertical stand posts with bevelled end grain section as constructive wood preservation measure



Perforated

The earth / air zone of the wood is perforated by numerous small bore holes to ensure that the impregnating agent penetrates this particularly endangered zone



Fürstenberg Permador System

In special cases we use the patented Fürstenberg Permador System as an additional protection against rot



Core-free

Sawn-timbers core-free, thus decreasing occurrences of cracking and undesired changes in shape



Claddings

Claddings made of mountain larch (4 – 5 cm). Peeled white by hand, natural tree surface remains tangible and perceptible



Tongue and groove

Tongue and groove planks made of 4 cm solid wood, highly resilient, no trickling of dust / sand, protection against direct rain



Laminated wood beams

Laminated wood beams made of non-impregnated larch, glued according to EN 14080:2013; for very large timber cross-sections; comparatively low shrinkage, almost completely free of cracks



Hardwood rungs

Climbing rungs made of hardwood (ash) Ø 4.2 cm, milled and mortised, secured against twisting, easy to grip and not cold for children to touch



Plywood

Plywood made of mountain larch, three-layer (3 cm) or five-layer (4 cm). High dimensional stability, waterproof, glued according to DIN EN 13353:2011



One-piece construction

Total construction of the slide made of 2 mm stainless steel, drawn in box form, surface glass bead blasted, without welding seam between sliding surface and side cheek



Swing seat

Ergonomically shaped swing seat made of rubber with soft shock absorbing edge. Durable due to strong profiled steel insert



Pendulum seat

Pendulum seat with a large rubber surface. Soft, protective edge and steel insert



Impact absorbing

The anti-slip swing platform is covered by a special tyre-like element for impact absorption



Richter Hercules type rope

Richter Hercules type rope, a combination of galvanised six-strand steel cables and polyester yarn, diameter > 20 mm, laid and glued with very good abrasion resistance, strong sheathing even in the case of damage by puncturing



Hercules rope

Hercules rope, for spliced net connections. A compound of steel rope for the core and polyester or polyamide yarn for the sheath. High abrasion resistance, 4 or 6 strands



Aluminium rope pressing

Aluminium rope pressing, cylindrically pressed, with rounded ends



S-connectors

S-connectors Ø 8.1 mm, made of high-quality stainless steel, rounded



Swing joint

Drop-forged, hot-dip galvanised swing joint with sintered bush and integrated swivel



Universal joint

Drop-forged, hot-dip galvanised universal joint, consists of two sintered bushes, for free swinging in any direction



Rotating rope connection

Rotatable fitting without dangerous openings, with sintered bush with integrated swivel to ensure the rope untwists



Rope connection fixed

Fixed rope connection without dangerous openings. Screw connection adjustable and countersunk in the wood



Rope connection with joint

Close-fitting connection with joint, without dangerous openings, with sintered bush and adjustable screw connection



Ball joint rope connection

Close-fitting rope connection with ball joint, without dangerous openings for free swinging in any direction, rotatable suspension with combination of plain bearings and roller bearings, adjustable screw connection



Double rope connection

Connection for complicated swing and swivel motion



Profiled washer

Profiled washer for covering protruding screw heads according to standard, improved pressure distribution and protection against water. Impedes loosening the bolt



Adjustable

Adjustable two-piece bolt connection, easy to maintain, no projecting threads



Interlocking

Interlocking connection, with milled metal rings or serrated disc dowels, to reinforce the bolt connection under high loads transverse to the grain direction of the wood



End grain connector

End grain connector as special fitting for the adjustable connection of horizontal and vertical timber



Sintered bush

For all reciprocating movements we use sintered plain bearings which are self-lubricating in use and can easily be exchanged if necessary



Steel reinforced rubber belt

Two-way steel reinforced rubber belt, total thickness approx. 11 mm, nearly indestructible



Large gated cableway

The large gated cableway covers the required safety distances. The cableway carriage comes to a smooth stop due to the difference in height of the gates and the cable slack



Tensioning device

Tensioning device enables one person to release and re-tension. Large winch radius and anti-kink function protect the rope



Cableway carriage

Our cableway carriage is designed as a sandwich construction. The „encapsulated“ running mechanism ensures quiet operation. The installation of the carriage is possible without dismantling the rope



Special steel cable

High density steel cable made of high-strength and hot-dip galvanized wire. Stable in length, durable and allows a smooth ride of the cableway carriage



Ground anchor

All parts used for anchoring to the ground are made of hot-dip galvanized steel or stainless steel



HPL ground anchor

Foundation anchor made of phenol resin paper-based laminates



Cross beam made of steel

Swing cross beam made of hot-dip galvanized steel. Optimized swing geometry with rigid corner connections, thus allowing for smaller foundations and easier foundation covering



Chains

Chains made of hot-dip galvanized steel (1.4301 / 1.4571 at extra charge) welded before galvanising, short-linked, without eyelets on the connecting parts, easy to exchange and shorten



Stainless Chains

Chains made of steel with high corrosion resistance. Short-linked, without eyelets on the connecting parts, easily replaceable and simple shortening



Distance fitting

Screw connection with distance fitting to avoid entrapment areas



Relief cut

Targeted relief cut as an effective measure against cracks caused by drying. The cut defines the position of the stress equalization in the trunk and minimises natural cracking



Roller bearings

Roller bearings made of stainless steel for rotating elements, easy to maintain and exchange, sealed



Fastening of rope

Fastening of rope / net by means of adjustable chain fixation, easy assembly and maintenance

Richter Wood Quality Criteria for Larch Wood

Origin

Exclusive use of mountain larch (bot. *larix decidua*) from the Alps. It grows 800 - 1800 m above sea level and comes from sustainable forestries. Our wood is PEFC certified according to CFC5 2002:2013/PEFC D 1003:2013. This certificate confirms that the sawn and round timber that is produced and sawn comes from sustainable forestry. Further information can be viewed on our website.

According to an official ranking, larch is a moderately rot-resistant type of wood - considerably less durable than robinia.

However, there are different kinds of larch. The larch which we use for our production grows in the mountains at a height of more than 800 m above sea level. Therefore, it has considerably better wood physical properties (and thus should actually be called *larix decidua montana*).

This advantages of this mountain grown larch are considerable:

- Less resin galls
- Less splinters
- Closer year rings
- Higher stability and predominantly enhanced durability.

Felling time

Our larch trees are felled in winter so that the cut wood can dry before fertile fungus spores, which can lead to early decomposition, appear.

Corning

During the natural ageing process of the tree, core materials are deposited in the wood. This corning is responsible for the rot-resistance of the mountain larch. Good corning and therefore suitability for ground insertion is recognisable to our colleagues by the red colour of the wood.

Sapwood

According to our wood quality criteria, timbers of mountain larch are delivered almost sapwood free.

Year rings

Wood with close year rings is more resistant to rot. Wood intended for ground insertion and for horizontal beams has particularly close rings. Our poles have at least 8 year rings in the outer 2 centimetres.

Evenness

We ensure that poles inserted into the ground and horizontal beams have centred rings so that close ring wood lies near the outer edge. We do not permit an eccentricity of the piths of greater than 3 cm.

Fungal attack

Occasionally even a standing tree is attacked by fungus. Such wood only gives limited durability, which is why we carefully sort it out.

Wood moisture

Wood-destroying fungi require high levels of moisture in the wood. We increase the lifespan of our wood through natural open-air drying. Advanced drying in the poles is demonstrated by the appearance of splits. Our sawn timber is already dried to around 15 - 20% of original wood moisture before it is used for construction.

Since 1989 we have manufactured much of our wooden play equipment of unimpregnated mountain larch. Our play equipment made of unimpregnated poles of mountain larch stands as a rule on steel feet. For short vertical pole length we do without steel feet construction more and more. For square timbers inserted into the ground we use oak core timber. The end-grained timber surfaces are cut on the cross and covered with paraffin wax.

All equipment printed in red in our price list is made from unimpregnated mountain larch which has been selected according to the eight Richter quality criteria.



Photo © Anton Donikov

In the Playground ...

Play value

The Sound Cushions provide an attractive activity for nearly all ages. Tones are produced by hopping on, or running over the cushions. Surprising tone sequences are produced, interrupted by amusing squeaks. This is a game for children and adults. As installation takes place using ground anchors rather than foundations, the tones can be changed any time. New sequences of movement are then required together with new tones and noises.



Photo © Ayumi Nakanishi



Photo © Anton Donikov

Sound Cushions

Fundamental characteristics

- Incentive for playing: „funny“ cushions on the ground, curiosity
- Movement: jumping, hopping, running

Recommended for

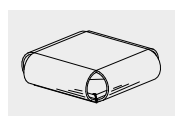

- Kindergarten children
- School children
- Supervised play areas, such as kindergartens, schools, after-school programmes or similar
- Swimming pools without supervision, such as outdoor pools, adventure pools or similar

Acoustic effect	medium / pipes
Vandalism	slightly vulnerable



9.02410

Order No. 9.02410
Sound Cushions
 Installation example

Safety distance 
 Device dimensions 
 Functional distance 

Technical information

Hopping surface made of textile-reinforced rubber belt, thickness 8 mm

Ground anchor

All parts used for anchoring to the ground are made of hot-dip galvanised steel or stainless steel



For more detailed explanation of the quality characteristics see price list.

Air spring with pipe, for installation in groups pentatonically tuned

Dimensions

(small deviations possible)

Height	0.15 m
Length	0.55 m
Width	0.55 m
Weight	25 kg

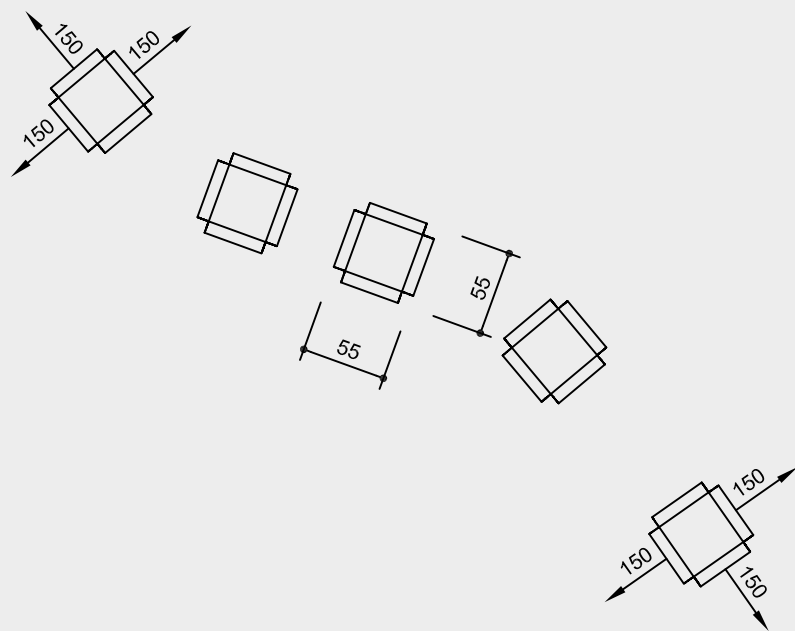

Scale 1:50

Safety check according to DIN EN 1176

Components

- 1 Hopper
- 2 Foundation irons

Installation information

Surfacing requirements corresponding to a fall height of ≤ 0.60 m (please refer to price list for more detailed information)

Foundations
 Excavation per item approx. 60 x 20 cm, 40 cm deep (only necessary to immobilise the equipment)

Attention:
Exact measurements may vary; for all installation dimensions refer to current assembly instructions.
 Technical changes reserved.

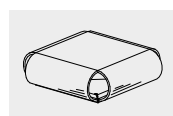

9.02410

Play value

The Wind Pipes are a simple sound equipment which enables the person „playing them“ to experience physically the relation of cause and effect. The three, ground level integrated see-saw beams can be moved independently from each other. Due to the movement of the beams, the air pressure which is required for playing the pipes is produced. By means of shifting the weight or moving from one beam to the other, different simple sequences of notes are produced. Six different notes are possible. Children enjoy very much making „music“ with the whole body or producing „beautiful“ (dreadful) sequences of notes by using the see-saw effect of the beams.



Fundamental characteristics

- Unique and original
- Combination of see-sawing and experience of sound
- Incentive for playing: surprising element on the ground
- Movement: shifting one’s weight

Recommended for

- Kindergarten children
- School children
- Young people
- Adults
- Older people
- Supervised play areas, such as kindergartens, schools, after-school programmes or similar
- Public play areas without supervision, such as playgrounds, parks or similar

Barrier-free

- Independent play

Planning information

To prevent the underground parts of the mechanism from being damaged, we strongly advise against installing the equipment in sand.



Wind Pipes

Acoustic effect	medium / pipes
Vandalism	not vulnerable
Supervision	recommended

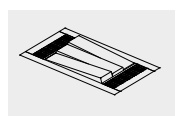

9.02400

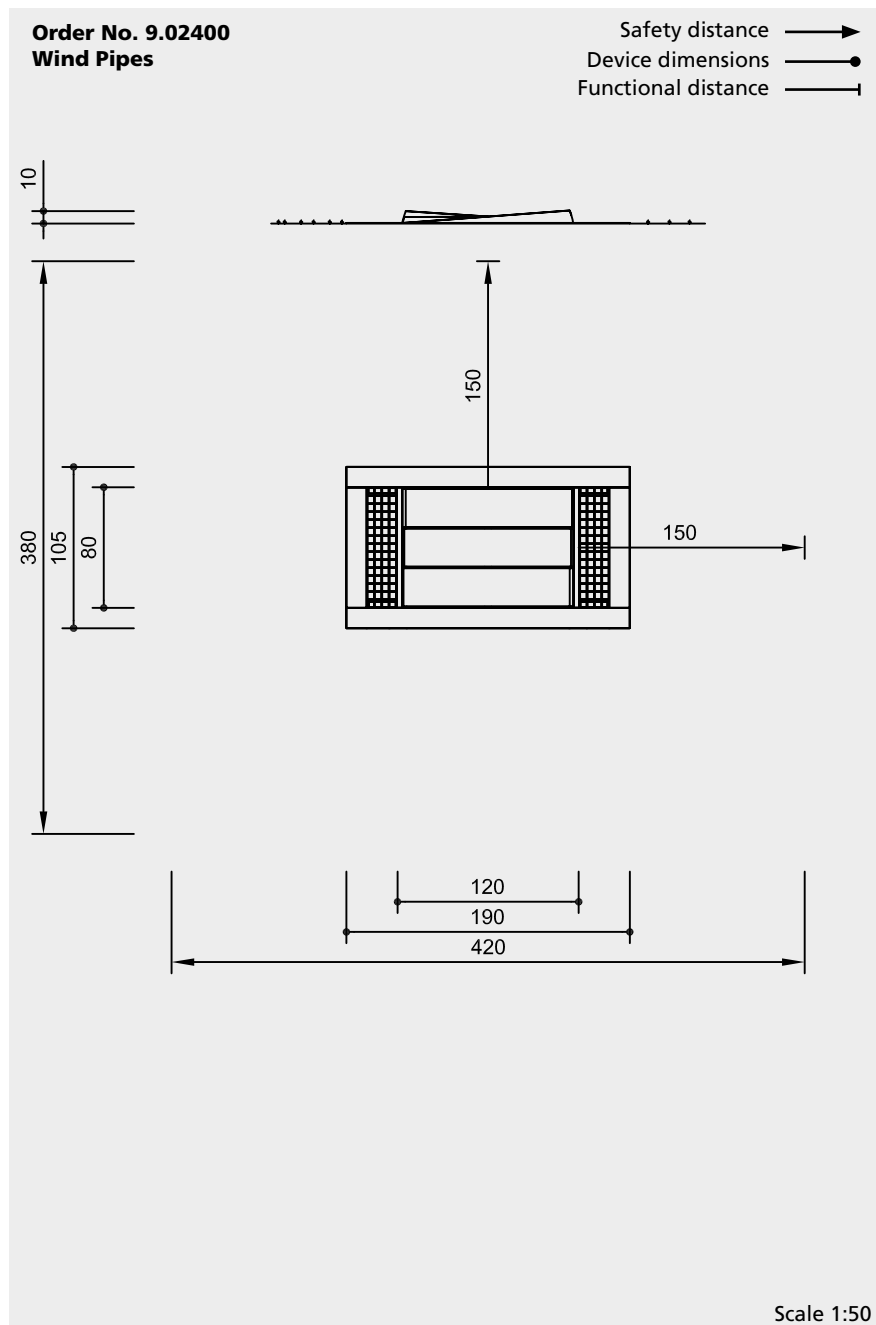

Safety check according to DIN EN 1176

Components

- 1 Complete equipment with 3 see-saw beams and 6 piston pumps with musical pipes

Installation information

Surfacing requirements corresponding to a fall height of ≤ 0.60 m (please refer to price list for more detailed information)

Foundations

Excavation: 125 x 220 x 63 cm
1 box foundation 125 x 220 x 50 cm with a wall thickness of 30 cm on the short side and 20 cm on the long side

Attention:

Exact measurements may vary; for all installation dimensions refer to current assembly instructions.

Technical changes reserved.

Technical information

Equipment made of non-impregnated mountain larch

Core-free

Sawn-timbers core-free, thus decreasing occurrences of cracking and undesired changes in shape



Sintered bush

For all reciprocating movements we use sintered plain bearings which are self-lubricating in use and can easily be exchanged if necessary



Ground anchor

All parts used for anchoring to the ground are made of hot-dip galvanised steel or stainless steel



For more detailed explanation of the quality characteristics see price list.

Piston pumps with pipes mounted under the see-saw beam

Pipes are tuned to the pentatonic scale

Ventilation from hot-dip galvanised grille

Dimensions

(small deviations possible)

Length	1.90 m
Width	1.05 m
See-saw beams	10 / 26 cm
Weight	180 kg

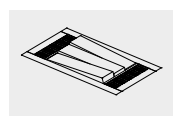

9.02400



Play value

By turning the individual rollers, different sounds are generated. Participants can balance by standing on the rollers or sit on the ropes pushing the rollers with their feet. Sounds are generated in an amusing way on the sound roller while sense of balance is improved.

Fundamental characteristics

- Experience of sound for sensitive perception
- Incentive for playing: rollers, holding ropes
- Movement: movement of feet, holding on, hanging

Recommended for

- School children
- Supervised play areas, such as kindergartens, schools, after-school programmes or similar
- Public play areas without supervision, such as playgrounds, parks or similar





Sound Roller

Acoustic effect	soft clanging
Vandalism	not vulnerable



9.02431

Order No. 9.02431
Sound Roller

Safety distance 
Device dimensions 
Functional distance 

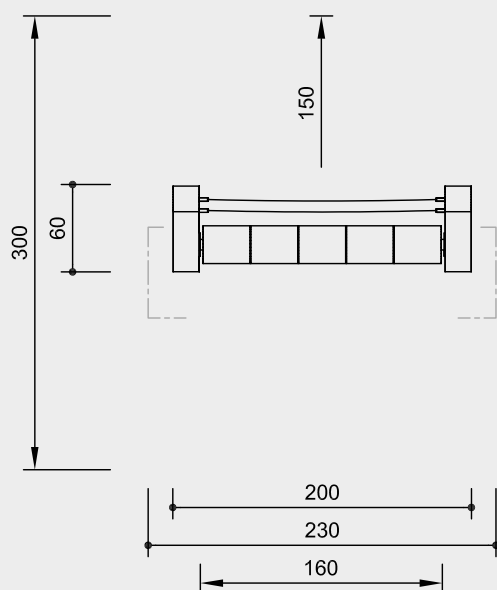
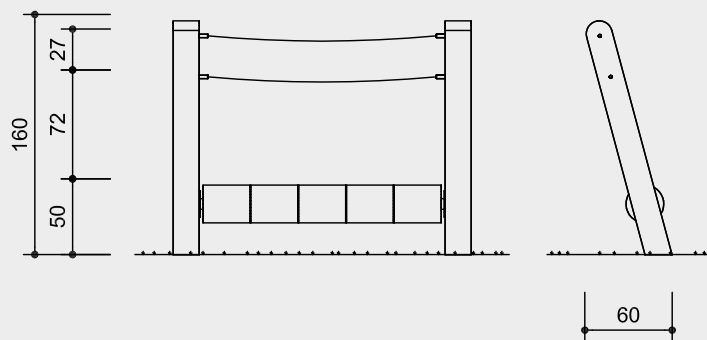

Scale 1:50

Safety check according to DIN EN 1176

Components

- 2 Support posts with steel feet and 2 ropes
- 1 Axle with 5 rollers on bearings

Installation information

Surfacing requirements corresponding to a fall height of ≤ 0.60 m (please refer to price list for more detailed information)

Foundations
1 item 60 x 60 x 60 cm
Excavation depth 80 cm

Attention:
Exact measurements may vary;
for all installation dimensions refer to current assembly instructions.
Technical changes reserved.

Technical information

Support posts made of square timber 18 / 18 cm, non-impregnated mountain larch

Core-free
Sawn-timbers core-free, thus decreasing occurrences of cracking and undesired changes in shape



Richter Hercules type rope
Richter Hercules type rope, a combination of galvanised six-strand steel cables and polyester yarn, diameter > 20 mm, laid and glued with very good abrasion resistance, strong sheathing even in the case of damage by puncturing



Aluminium rope pressing
Aluminium rope pressing, cylindrically pressed, with rounded ends



Rope connection fixed
Fixed rope connection without dangerous openings. Screw connection adjustable and countersunk in the wood



Profiled washer
Profiled washer for covering protruding screw heads according to standard, improved pressure distribution and protection against water. Impedes loosening the bolt



Sintered bush
For all reciprocating movements we use sintered plain bearings which are self-lubricating in use and can easily be exchanged if necessary



Ground anchor
All parts used for anchoring to the ground are made of hot-dip galvanised steel or stainless steel



For more detailed explanation of the quality characteristics see price list.

Dimensions

(small deviations possible)

Height	1.60 m
Length	2.00 m
Depth	0.60 m
Weight	250 kg

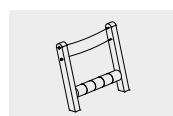

9.02431

Play value

Three wooden columns with pump handles are placed around a central post. Raising and lowering the levers produces air pressure which drives sound elements. Pumping produces different triads. Playing together with the Wind Pump produces elementary experience of rhythm and tone using simple hand movements. This attractive play equipment is an appealing enhancement of parks and leisure areas. It is just as suited as a central feature of play areas.



Wind Pumps

Fundamental characteristics

- Unique and original
- Harmonic design
- Incentive for playing: interesting installation, curiosity
- Movement: pumping

Recommended for

- School children
- Supervised play areas, such as kindergartens, schools, after-school programmes or similar
- Public play areas without supervision, such as playgrounds, parks or similar

Barrier-free

- Independent play



Acoustic effect	strong / pipes
Vandalism	not vulnerable

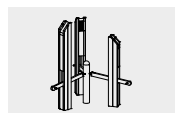

9.02500

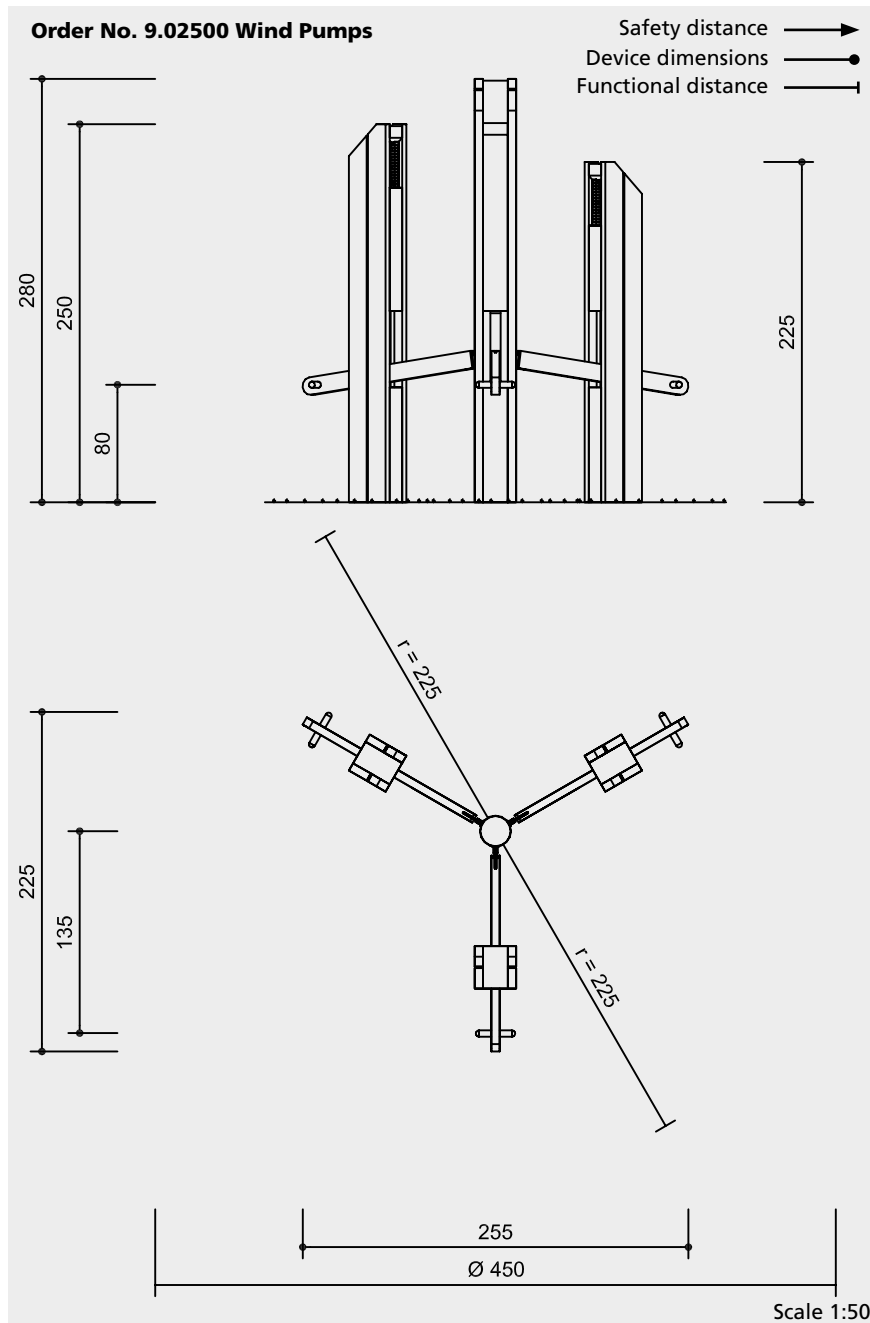

Safety check according to DIN EN 1176

Components

- 3 Individual pumps with integrated sound elements and steel feet
- 1 Central column with 3 levers and steel foot

Installation information

Surfacing requirements
no requirements

Foundations
4 items 50 x 50 x 60 cm
Excavation depth 80 cm

Attention:
Exact measurements may vary; for all installation dimensions refer to current assembly instructions.
 Technical changes reserved.

Technical information

Equipment made of non-impregnated mountain larch

Peeled white

Palisades peeled white means that bark, cambium and sapwood are removed, the natural shape of the trunk is preserved and can be experienced



Core-free

Sawn-timbers core-free, thus decreasing occurrences of cracking and undesired changes in shape



Ground anchor

All parts used for anchoring to the ground are made of hot-dip galvanised steel or stainless steel



For more detailed explanation of the quality characteristics see price list.

1 piston pump per column each with 2 pipes, tuned to the pentatonic scale

Hot-dip galvanised fittings

Dimensions

(small deviations possible)

Height	2.80 m
Weight	300 kg



9.02500



Order No. 9.02652 Sea Roarer free-standing

Play value

The play possibilities of Sea Roarer are not apparent until the user steps onto the stainless steel platform and discovers the pivotally rotating movements it allows. These movements are fun, and increased play value is achieved when users interact with each other. Gradually the players become conscious of a special sound. Concentration turns more and more to listening and exploring how the movement controls the sound – they discover the roar of the sea. Below the surface are many little balls, which move when the position of the standing plate is changed. The balls roll over a membrane producing a sound which is similar to that of the sea rolling in and out of the shore. The senses of balance and hearing are both challenged and stimulated, heightening the awareness of the senses through play activity.

Another exciting acoustic phenomenon can be experienced with our piper. Two sound tubes together make up a set. One serves as a pump while the other determines the pitch of the tone. The movable metal rod is used to draw air upwards into the sound element and to push it downwards. The second sound element then simultaneously generates a piping sound. Different chord progressions can be generated depending on the speed of the pump and how the tone pitch is controlled.

Fundamental characteristics

- Unique and original
- High-quality design appeals to the senses
- Incentive for playing: appealing design, curiosity
- Movement: balancing, experiencing one's whole body



Order No. 9.02650 Sea Roarer

Recommended for

- School children
- Young people
- Supervised play areas, such as kindergartens, schools, after-school programmes or similar
- Public play areas without supervision, such as playgrounds, parks or similar

Barrier-free

- Special exercise experience
- Independent play (piper)

**Sea Roarer
Sea Roarer free-standing
Piper**



Order No 9.02660 Piper

Acoustic effect	soft to strong depending on usage
Vandalism	not vulnerable

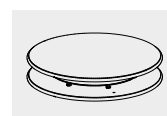

9.02650 / 9.02652

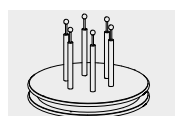

9.02660

Order No. 9.02650 / 9.02652
Sea Roarer

Safety distance 
 Device dimensions 
 Functional distance 

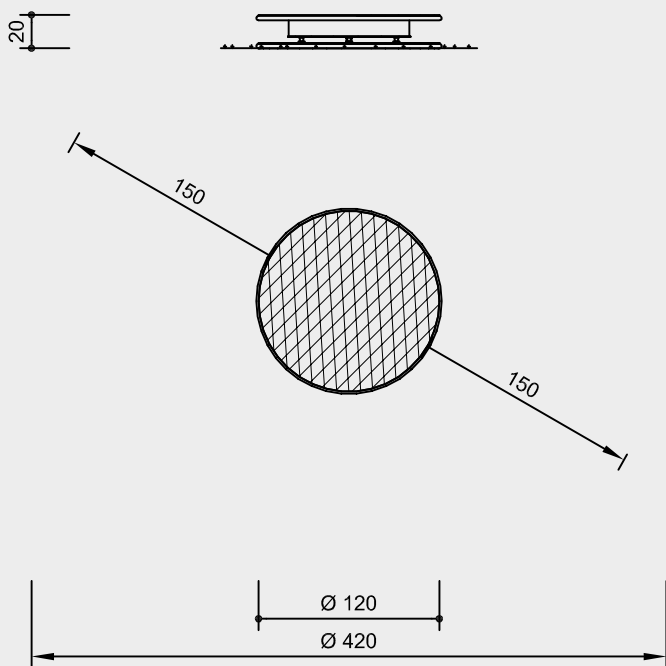

Order No. 9.02660
Piper

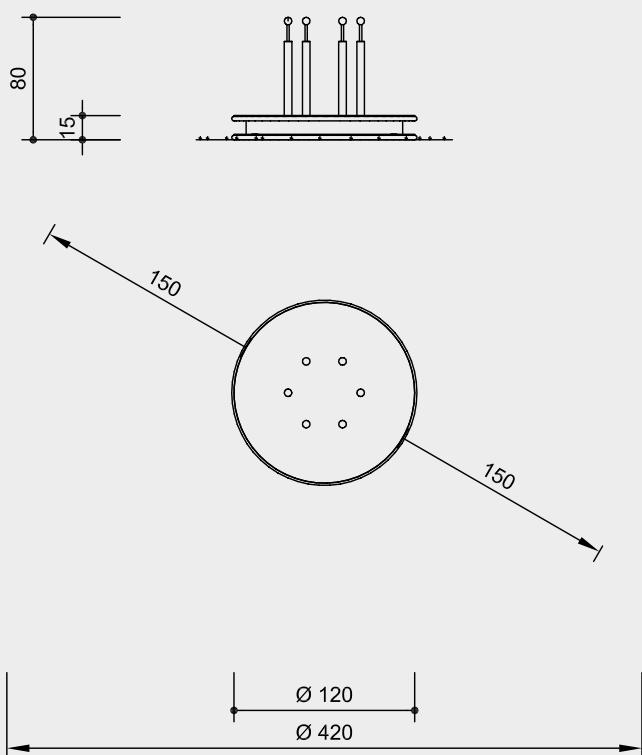

Scale 1:50

Safety check according to DIN EN 1176

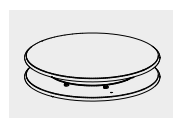

9.02650 / 9.02652

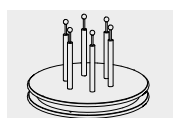

9.02660

Technical information

Equipment entirely made of stainless steel, glass bead blasted, with sound elements

Ground anchor

All parts used for anchoring to the ground are made of hot-dip galvanised steel or stainless steel



For more detailed explanation of the quality characteristics see price list.

Order No. 9.02652
Sea Roarer free-standing

Rubber buffer made of hard rubber abrasion-resistant

Order No. 9.02660
Piper

Pipes made of phenolic resin, different colour pairs

Dimensions

(small deviations possible)

Order No. 9.02650 / 9.02652
Sea Roarer

Height	0.20 m
Diameter	1.20 m
Weight	130 / 120 kg

Order No. 9.02660
Piper

Height	0.15 m
Height incl. pipes	0.80 m
Diameter	1.20 m
Weight	70 kg

Components

Order No. 9.02650
Sea Roarer

- 1 Piece of equipment
- 3 Foundation irons

Order No. 9.02652
Sea Roarer free-standing

- 1 Piece of equipment
- 6 Rubber buffers

Order No. 9.02660
Piper

- 1 Piece of equipment
- 3 Foundation irons

Installation information

Surfacing requirements corresponding to a fall height of ≤ 0.60 m (please refer to price list for more detailed information)

Foundations

Order No. 9.02650 / 9.02660

- 3 items 40 x 40 x 35 cm
- Excavation depth 40 cm

Attention:

Exact measurements may vary; for all installation dimensions refer to current assembly instructions.

Technical changes reserved.



Order No. 9.02710 Phones in Concrete

Play value

The Phones are an attractive play item which confront people with the physical phenomena of sound waves and sound wave transmission during play. Children are fascinated when they can actually hear the voice of their play partner clearly at a distance of approximately 15 m. This telephone can also be incorporated in role play and becomes particularly interesting when bushes or trees obscure the view to give an illusion of a big distance to be bridged.

Fundamental characteristics

- Agreeable design
- Enables communication over a big distance
- Movement: bending, stretching

Recommended for

- Kindergarten children
- School children
- Supervised play areas such as kindergartens, schools, after school programmes or similar
- Public play areas without supervision such as playgrounds, parks or similar

Barrier-free

- Independent play



Order No. 9.02700 Phones in Wood

**Phones in Wood
Phones in Concrete**



Acoustic effect	soft
Vandalism	not vulnerable



9.02700

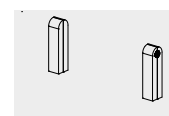

9.02710

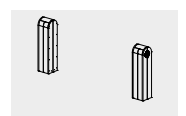

9.02720

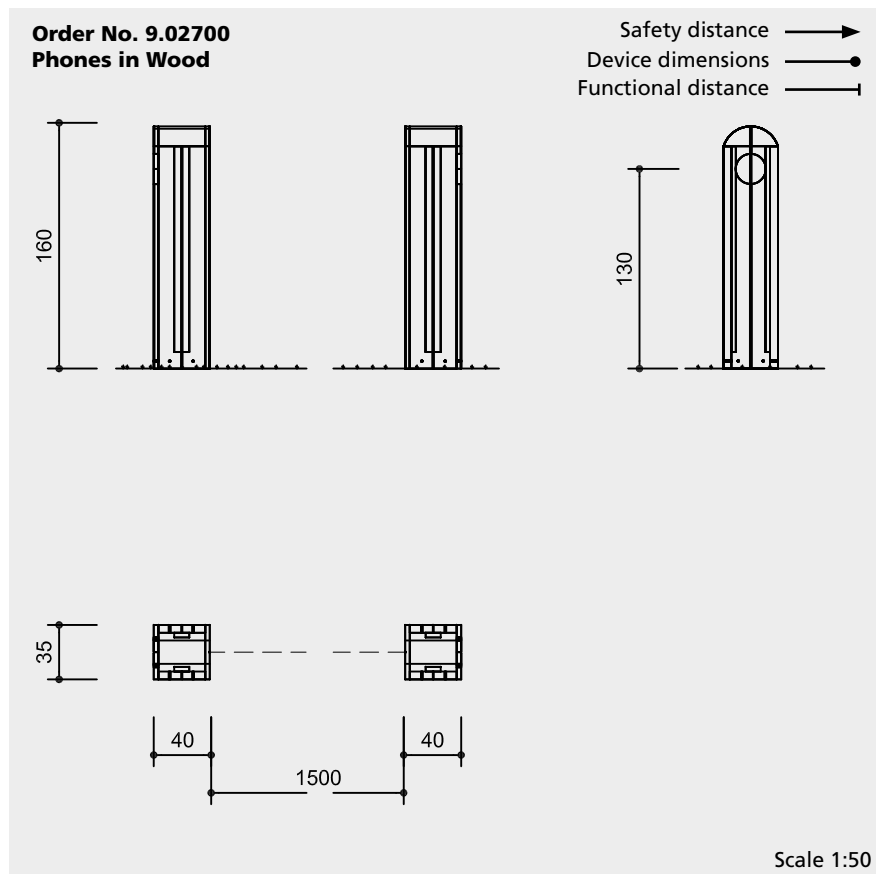

Safety check according to DIN EN 1176

Components

- 2 Phones
- 17 m plastic pipe and accessories
- 2 Foundation frames

Installation information

Surfacing requirements
no requirements

Foundations

Order No. 9.02700 / 9.02720
Phones in Wood

2 items 60 x 60 x 35 cm
Excavation depth 40 cm

Order No. 9.02710
Phones in Concrete

no foundation work necessary
Excavation 60 x 55 x 55 cm
A well-compacted soil with good carrying capacity is required, if necessary use gravel or, respectively, a blinding layer.

Groundwork necessary for connection pipe

The distance between the two phones should be approx. 15 m, max. 17 m.

Attention:
Exact measurements may vary;
for all installation dimensions refer
to current assembly instructions.
Technical changes reserved.

Technical information

Order No. 9.02700 / 9.02720
Phones in Wood

Core-free

Sawn-timbers core-free, thus decreasing occurrences of cracking and undesired changes in shape



Ground anchor

All parts used for anchoring to the ground are made of hot-dip galvanised steel or stainless steel



For more detailed explanation of the quality characteristics see price list.

Mouthpieces closed with communication grille of stainless steel, connected with plastic pipes

Order No. 9.02710
Phones in Concrete

Each column is cast as 1 part of vibrated concrete C 30/37

Mouthpieces closed with communication grille of stainless steel, connected with plastic pipes

Dimensions

(small deviations possible)

Order No. 9.02700
Phones in Wood

Height	1.60 m
Mouthpiece	1.30 m
Width	0.35 m
Depth	0.40 m
Weight	150 kg

Order No. 9.02710
Phones in Concrete

Height	1.50 m
Mouthpiece	1.30 m
Width	0.35 m
Depth	0.40 m
Weight	720 kg

Order No. 9.02720
Phones in Wood for kindergartens

Height	1.20 m
Mouthpiece	0.90 m
Width	0.35 m
Depth	0.40 m
Weight	130 kg

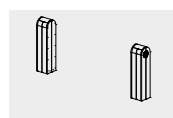

9.02700

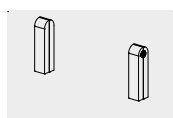

9.02710

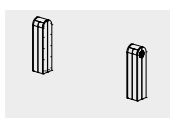

9.02720



Play value

Our Ear and Speaking Trumpets are an attractive piece of play equipment, which can be used in lots of different ways. The transmission of voices and sound through the funnels begins with listening to a gentle sound and then becomes intriguing when you become aware of the amplification effect. In order to achieve good results, the "trumpets" must face each other precisely. Since the trumpets can be rotated 360° and swivelled vertically, it is possible to mount several of them at different heights. For speaking and listening, two of them have to be adjusted individually so that they are precisely in line with each other. The funnels can be integrated into role playing games in countless ways - small and big children alike are fascinated by being able to communicate with each other over a certain distance.

Recommended for

- School children
- Young people
- Adults
- Older people
- Supervised play areas such as kindergartens, schools, after-school programmes or similar
- Public play areas without supervision such as kindergartens, schools, after school programmes or similar

Barrier-free

- Special version for wheelchair users optional



Acoustic effect	soft
Vandalism	not vulnerable
Supervision	not required
Explanation Board	recommended
Installation	indoors and outdoors
Safety check (DIN EN 1176)	not required
Installation in concrete	possible

Ear and Speaking Trumpet



9.03000

Order No. 9.03000
Ear and Speaking Trumpet
 Example with 2 trumpets

Safety distance 
 Device dimensions 
 Functional distance 

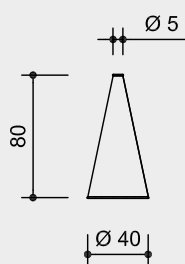
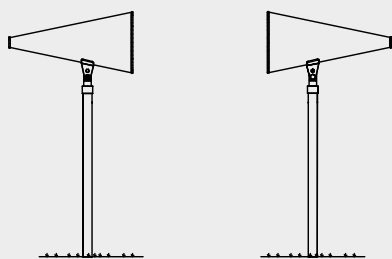
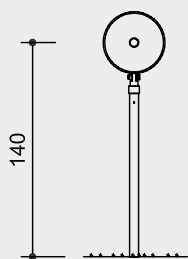

Distance between ear and speaking trumpets 15–40 cm

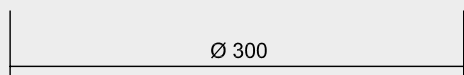

Scale 1:50

Technical information

Equipment made of stainless steel

Sintered bush

For all reciprocating movements we use sintered plain bearings which are self-lubricating in use and can easily be exchanged if necessary



Ground anchor

All parts used for anchoring to the ground are made of hot-dip galvanised steel or stainless steel



For more detailed explanation of the quality characteristics see price list.

Funnel-shaped opening, rotating mechanism (PE), can be swivelled vertically

Dimensions

(small deviations possible)

Height	1.40 m
Depth	0.80 m
Weight of trumpet with support post	22 kg

Components

Depends on number of pieces ordered

Minimum number = 2 trumpets for dowelling, incl. 4 heavy duty anchors each

Installation information

Recommended space including safety distances
 Circle diameter = 300 cm per "trumpet"

Foundations
Order No. 9.03000
Ear and Speaking Trumpet
 1 item 40 x 40 x 40 cm for each "trumpet"
 Excavation depth 60 cm

Note
 No obstacle (other devices) may be positioned in the direct line between the two devices as this would greatly impair the function of the device.

Attention:
Exact measurements may vary; for all installation dimensions refer to current assembly instructions.
 Technical changes reserved.



9.03000

Play value

Sound, like light and heat, can be made to focus. What is spoken at normal volume into the focal point of the reflector can be picked up in a second reflector placed opposite about 30 to 40 m away, as well as at all points between the two reflectors. Sound waves, like light and heat waves, can be concentrated onto one particular spot. The Parabolic Reflector provides experience of physical phenomena.

Fundamental characteristics

- Incentive for playing: large reflectors
- Movement: listening

Recommended for

- Schoolchildren
- Young people
- Adults
- Older people
- Public play areas without supervision, such as playgrounds, parks or similar

Barrier-free

- Independent play



Photo © Daniel Perales

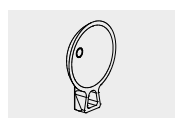

Photo © Daniel Perales





Parabolic Reflectors made of concrete

Acoustic effect	soft
Vandalism	not vulnerable



9.05000

Order No. 9.05000
Parabolic Reflectors made of concrete

Safety distance 
 Device dimensions 
 Functional distance 

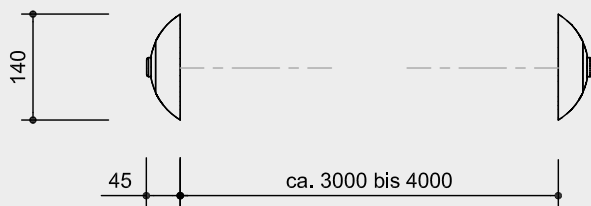

Scale 1:100

Safety check according to DIN EN 1176

Components

- 2 Concrete Parabolic Reflectors with stand feet
- 2 Pylon frames
- 2 Foundation irons

Installation information

Surfacing requirements
 no requirements

Foundations
 each item 50 x 50 x 80 cm
 Excavation depth 80 cm
 optical measurement with levelling instrument recommended

Attention:
Exact measurements may vary;
for all installation dimensions refer
to current assembly instructions.
 Technical changes reserved.

Technical information

Each reflector is cast as 1 part of vibrated concrete C 30/37, steel-reinforced

Ground anchor

All parts used for anchoring to the ground are made of hot-dip galvanised steel or stainless steel



For more detailed explanation of the quality characteristics see price list.

Dimensions

(small deviations possible)

Height	1.80 m
Diameter	1.40 m
Weight per reflector	520 kg



9.05000

Play value

The Dance Chimes connect movement with experience of sounds. People of nearly all ages enjoy producing bright tones by hopping, jumping, or even dancing. Few play items produce so much smiling as this one. Both the spectators and listeners feel a moment of lightness, joy and harmony. The strong motivation produced by the Dance Chimes helps people to overcome physical inhibitions and to harmonise uncoordinated movements. However, even arbitrary hopping produces pleasant sounds which are pentatonic sequences rather than normal tones. Nine brass tiles are arranged in a square with a sound element under each. These are set into vibration by the energy of motion and thus produce ringing tones. The Dance Chimes are also valuable as therapeutic equipment for people with a variety of functional limitations and they are a very attractive and demanding play offer for young children.

Fundamental characteristics

- Unique and original
- High-quality, sturdy construction
- Incentive for playing: surprising element on the ground, curiosity
- Movement: jumping, hopping, dancing



Special version with perforated plate
Photo © Daniel Perales

Dance Chimes

Recommended for

- Kindergarten children
- School children
- Supervised play areas such as kindergartens, schools, after-school programmes or similar
- Public play areas without supervision, such as playgrounds, parks or similar

Barrier-free

- Independent play



Acoustic effect	medium / tubular bells
Vandalism	not vulnerable

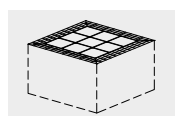

9.06000

Order No. 9.06000
Dance Chimes

Safety distance 
 Device dimensions 
 Functional distance 

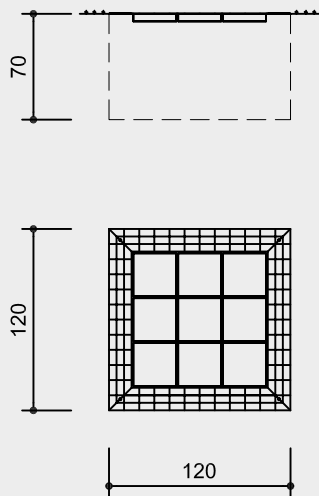

Scale 1:50

Safety check according to DIN EN 1176

Components

- 1 Dance Chimes unit completely mounted in a corrosion protected steel housing, with 9 sound elements, pentatonically tuned and tiles of brass with sensitive hammer mechanism

Installation information

- Surfacing requirements
- Firm ground, asphalt, concrete, paving or slabs
 - The housing is lowered into the ground so that the brass tiles are level with the surrounding surface
 - To prevent spontaneous resonance, any hollow areas around the housing should be filled with sand

A foundation ist not necessarily required. Ground which is able to take a load and which is well compressed covered with gravel or a blinding layer is sufficient.

Excavation:
 Pit 1.40 x 1.40 m
 at least 0.70 m deep
 with drainage

Attention:
Exact measurements may vary;
for all installation dimensions refer
to current assembly instructions.
 Technical changes reserved.
Equipment also available with elec-
trical Order No. 9.06102 or mechani-
cal Order No. 9.06106 shut-off device
(see also price list)

Technical information

We are continuously asked if the price demanded for this equipment is not a little high. Consequently, we feel obliged to explain the sales price of this equipment. Its price is calculated no differently to any of our others. Even careful re-calculation has revealed no undue costs. All who see the high quality material, the complicated mechanism, and the clean finish understand the real value of the equipment. In your interests, its price-value relationship has been double checked and we can therefore say with a clear conscience that the Dance Chimes are worth the money.

In order for play, dance and music to form an inseparable, mutually reinforcing entity, the following and further mechanical aspects are necessary, to guarantee problem-free operation:

- Sophisticated bearings
- Precise movement, which guarantees parallel movement and thus prevents any slippage
- Return mechanism which presses the foot plate into its original position
- Buffers which prevent metal-on-metal contact
- Pentatonically-tuned tone elements which always produce a harmonious sound
- The high-quality brass foot plates which become more attractive the more they are used
- The hot-dip galvanised housing which protects the various tone elements.

Dimensions
 (small deviations possible)

height	0.70 m
length	1.20 m
width	1.20 m
weight	450 kg

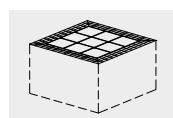

9.06000

Play value

This special **instrument** invites people to make music by playing the keys. It is available in two versions: The diatonic version is better suited to playing known melodies, while the pentatonic version is a motivation for free improvisation. This attractive play equipment is an appealing enhancement for any park and can serve as the exciting central feature of a play space.

Sound tubes are mounted on metal bars. They make sounds when they are hit by a small hammer activated by a pedal. Nearly everyone enjoys making sounds and therefore, this **wall** made from bars is very attractive both for young and older people. Due to the tubes of different lengths, the sound wall is a real music instrument which can produce a melody when „played“.

Fundamental characteristics

- Unique and original
- Incentive for playing: curiosity, percussion keys, sound elements
- Experiencing sound, making music
- Movement: beating

Recommended for

- Kindergarten children
- School children
- Young people
- Adults
- Older people
- Supervised play areas, such as kindergartens, schools, after-school programmes or similar
- Public play areas without supervision, such as playgrounds, parks or similar

Barrier-free

- Independent play



Order No. 9.05500 / 9.05510 Instrument, Photo © Iliya Varlamov

**Instrument
Sound Wall**



Acoustic effect	medium
Vandalism	not vulnerable

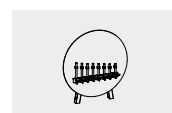



9.05500 / 9.05510



9.06710

Order No. 9.05500 / 9.05510

Instrument

Safety distance 
 Device dimensions 
 Functional distance 

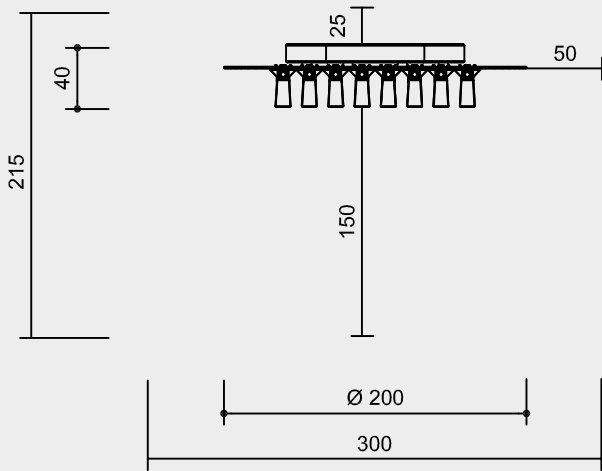
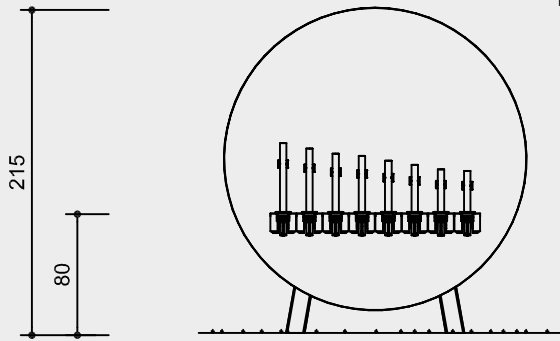

Order No. 9.06710
Sound Wall

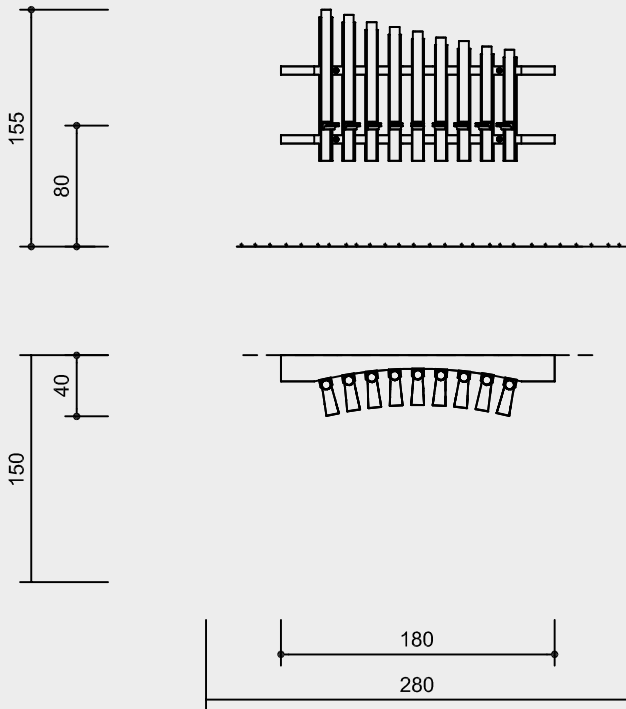

Scale 1:50

Safety check according to DIN EN 1176

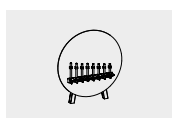

9.05500 / 9.05510

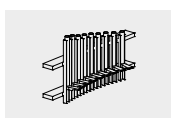

9.06710

Attention:
 Exact measurements may vary; for all installation dimensions refer to current assembly instructions.
 Technical changes reserved.

Technical information

Order No. 9.05500 / 9.05510
Instrument

Equipment made of stainless steel, sanded
 Sound tubes of hot-dip galvanised, weldless steel, mounted in stainless steel profiles
 Percussion mechanism is dampened by robust rubber buffers
 Percussion keys made of anodise aluminium

Order No. 9.06710 Sound Wall

Sound tubes of hot-dip galvanised, weldless steel, mounted in varnished U-profiles

Core-free

Sawn-timbers core-free, thus decreasing occurrences of cracking and undesired changes in shape



For more detailed explanation of the quality characteristics see price list.

Tuned to a pentatonic scale (in groups)
 Percussion mechanism is dampened by robust rubber buffers in every direction
 Percussion keys made of oak

Dimensions

(small deviations possible)

Order No. 9.05500 / 9.05510

Instrument
 Height 2.15 m
 Diameter 2.00 m
 Width 0.40 m
 Weight 450 kg

Order No. 9.06710 Sound Wall

Width 1.80 m
 Length of Sound elements 0.75 – 1.00 m
 Weight 180 kg

Components

Order No. 9.05500 / 9.05510

Instrument
 1 Disc
 1 Support frame

Order No. 9.05500
 tuned to a pentatonic scale

Order No 9.05510
 tuned to a diatonic scale

Also available for wall attachment.

Order No. 9.06710 Sound Wall

1 Sound Wall with 9 notes for attachment

The sound wall is also available with stand posts for in-situ concrete, **Order No 9.06720.**

Installation information

Surfacing
 no requirements

Order No. 9.05500 / 9.05510
Instrument

2 items 60 x 60 x 40 cm
 Exavation depth 60 cm



Photo © Mary Noble Ours

Play value

Stainless steel sheets are curved into a U shape and then welded in this shape to a hollow tube, which serves as a resonator. When the U-shaped steel sheets are hit with a beater, a warm lively sound is created. The resonator is not just open at the top of the hollow tube but also at the bottom. If this opening is closed off with the hand, the sound volume can be increased or decreased and the resonance of the sound in the air can be experienced. This tuning makes it possible for everybody to immediately create pleasant sounds, without any disharmony.

Fundamental characteristics

- Unique and original
- Exclusive design
- Incentive for playing: form, beater

Recommended for

- School children
- Supervised play areas, such as kindergartens, schools, after-school programmes or similar
- Public play areas without supervision, such as playgrounds, parks or similar

Barrier-free

- Independent play



Photo © Iliya Varlamov

Ferraphone



Photo © Valentin Luthiger

Acoustic effect	soft
Vandalism	not vulnerable



9.07000

Order No. 9.07000
Ferraphone

Safety distance →
 Device dimensions —●—
 Functional distance —|—

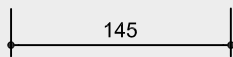
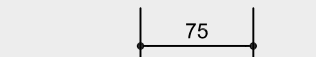
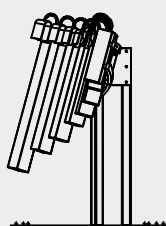
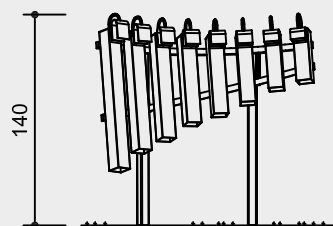

Scale 1:50

Safety check according to DIN EN 1176

Components

- 1 Ferraphone for dowelling with 2 beaters, incl. 4 heavy duty anchors

Installation information

Surfacing requirements
 no requirements

Foundations
 1 item 120 x 50 x 30 cm
 Excavation depth 50 cm
 for fixation with bolts

Attention:
Exact measurements may vary;
for all installation dimensions refer
to current assembly instructions.
 Technical changes reserved.

Technical information

Equipment made of stainless steel,
 glass bead blasted

Ground anchor

All parts used for anchoring to the
 ground are made of hot-dip galvanised
 steel or stainless steel



**For more detailed explanation of the
 quality characteristics see price list.**

Beater with rubber head, suspension
 made of stainless steel cable

Dimensions

(small deviations possible)

Height	1.40 m
Width	1.45 m
Depth	0.85 m
Weight	85 kg



9.07000



Order No. 9.08500 Kling Klang Disc with support post

Play value

The Kling Klang Disc is a play offer for people of all age groups. By turning of the disc, the spheres start moving and touch the obstacles inside, thus producing an amiable „kling-klang“ sound. It is not only fun to discover the different nuances of sound, but also to observe the way of the rolling spheres. The Kling Klang Disc is available for wall attachment or with support post.

Fundamental characteristics

- Unique and original
- Pleasant design
- Visual and aural experience
- Incentive for playing: turning disc, spheres, curiosity
- Experience: sounds, cause and effect

Recommended for

- School children
- Supervised play areas, such as kindergartens, schools, after-school programmes or similar
- Public play areas without supervision, such as playgrounds, parks or similar

Barrier-free

- Independent play



Order No. 9.08000 Kling Klang Disc for wall attachment, Photo © Daniel Perales

**Kling Klang Disc for wall attachment
Kling Klang Disc with support post**



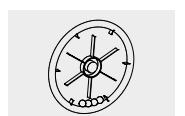

Order No. 9.08500 Kling Klang Disc with support post, Photo © Daniel Perales

Acoustic effect	soft
Vandalism	not vulnerable



9.08000 / 9.08500

Order No. 9.08000
Kling Klang Disc for wall attachment

Safety distance 
 Device dimensions 
 Functional distance 

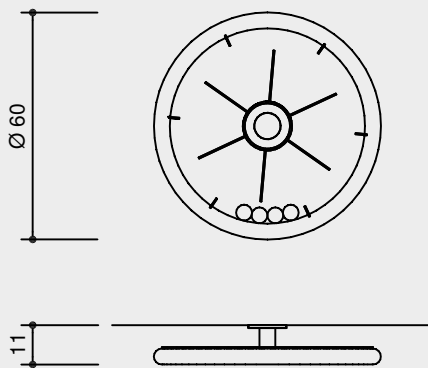

Order No. 9.08500
Kling Klang Disc with support post

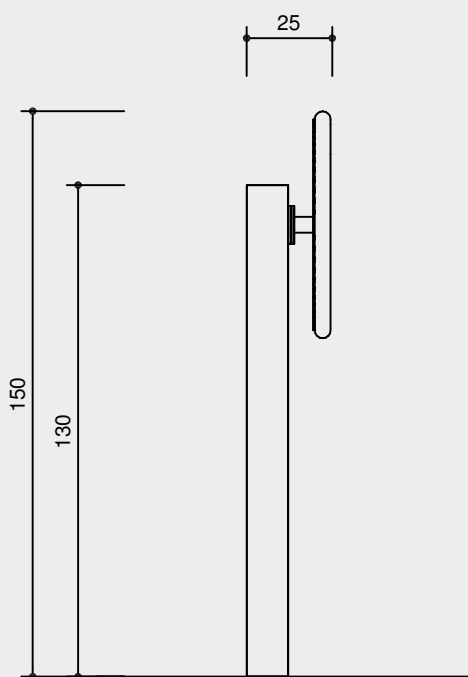

Scale 1:20

Safety check according to DIN EN 1176

Components

Order No. 9.08000

1 Kling Klang Disc

Order No. 9.08500

1 Kling Klang Disc
 1 Support post for dowelling,
 incl. 4 heavy duty anchors

Installation information

Recommended space
 diameter 1.50 m

Foundations

Order No. 9.08500
Kling Klang Disc
with support post
 1 item 50 x 50 x 40 cm

Excavation depth 60 cm, for dowelling

Attention:

Exact measurements may vary;
for all installation dimensions refer
to current assembly instructions.

Technical changes reserved.

Technical information

Sound disc made of stainless steel,
 glass bead blasted

Roller bearings

Roller bearings made of stainless steel
 for rotating elements, easy to maintain
 and exchange, sealed



For more detailed explanation of the
quality characteristics see price list.

Order No. 9.08500

Kling Klang Disc
with support post

As above, but in addition with

Ground anchor

All parts used for anchoring to the
 ground are made of hot-dip galvanised
 steel or stainless steel



For more detailed explanation of the
quality characteristics see price list.

Transparent cover disc made of Makrolon

Spheres made of hard plastic

Dimensions

(small deviations possible)

Order No. 9.08000

Kling Klang Disc for wall attachment

Diameter	0.60 m
Depth	0.11 m
Weight	30 kg

Order No. 9.08500

Kling Klang Disc with support post

Diameter	0.60 m
Depth	0.25 m
Height of support post	1.30 m
Weight	100 kg

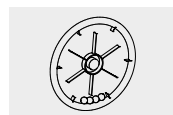

9.08000 / 9.08500



Photo © Daniel Perales

... and „everywhere“



Order No. 10.11010 Impulse Spheres with Frame made of stainless steel



Order No. 10.11010 Impulse Spheres with Frame made of stainless steel

Play value

Nine freely suspended spheres are hung in a row, touching each other. If the first one is pulled back and released to collide with the others, something truly amazing can be experienced. The impact force of the sphere travels unseen through the whole row of spheres until it finds its opposite number, the last sphere, which is forced outwards and, with almost equal energy, returns to collide with the row of spheres. The procedure is repeated until the force is dissipated. One or more spheres can be used to create endless variations and number games in a variety of rhythms. The laws of elasticity and energy can be experienced.

Recommended for

- Kindergarten children
- School children
- Young people
- Adult
- Senioren



Impulse Spheres
graubner Play Stations for
 Developing the Senses

Acoustic effect	medium
Vandalism	slightly vulnerable
Supervision	not necessary
Explanation Board	recommended
Installation	indoors and outdoors
Safety check (EN 1176)	has been completed
Installation in concrete	possible

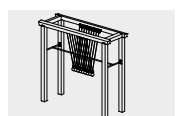

10.11000

Order No. 10.11000
Impulse Spheres

Safety distance →
 Device dimensions ●
 Functional distance —

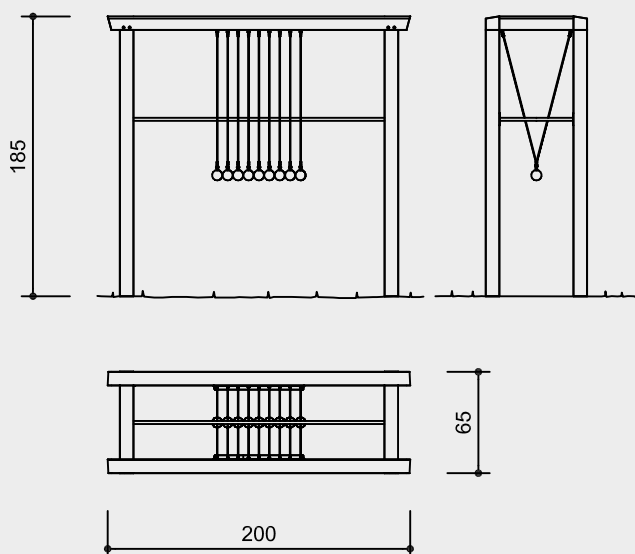

Scale 1:50

Safety check according to DIN EN 1176

Components

- 1 Complete piece of equipment
 Frame made of oak
 with 9 stainless steel spheres

Trademark

30 2005 500 000 Germany
 40-0682207 South Korea

Explanation board on request

Installation information

Recommended space
 4.05 x 3.00 m

Foundations
 2 items 40 x 100 x 40 cm
 Excavation depth 60 cm

Attention:

**Exact measurements may vary;
 for all installation dimensions refer
 to current assembly instructions.**
 Technical changes reserved.
**Frame also available in stainless
 steel, see Order No. 10.11010 in
 pricelist.**

Technical information

Frame made of oak

Core-free

Sawn-timbers core-free, thus decreasing occurrences of cracking and undesired changes in shape



For more detailed explanation of the quality characteristics see price list.

Only wood joints in accordance with traditional carpentry

Suspended on stainless steel cable

Fastening of suspension frame using adjustable attachments

High-quality, specially hardened stainless spheres (Ø 70 mm), for optimum impulse

Angle and limiting bar made of stainless steel

Dimensions

(small deviations possible)

Height	1.85 m
Length	2.00 m
Width	0.65 m
Weight	110 kg

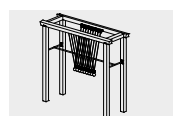

10.11000

Play value

If you place your head in the stone's hollow and hum different notes, it is possible to find the note at which resonance occurs, and this causes a pleasant gently vibrating sensation throughout your body. You are transported into your own private world.

Recommended for

- School children
- Young people
- Adults
- Older people
- Public play areas without supervision, such as playgrounds, parks or similar

Barrier-free

- Independent play



Small Singing Stone
graubner Play Stations for
 Developing the Senses

Acoustic effect	soft
Vandalism	not vulnerable
Supervision	not necessary
Explanation Board	included
Installation	indoors and outdoors
Safety check (DIN EN 1176)	not necessary
Installation in concrete	possible

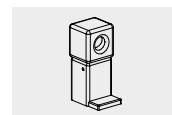

10.41100

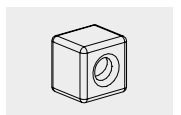

10.41300

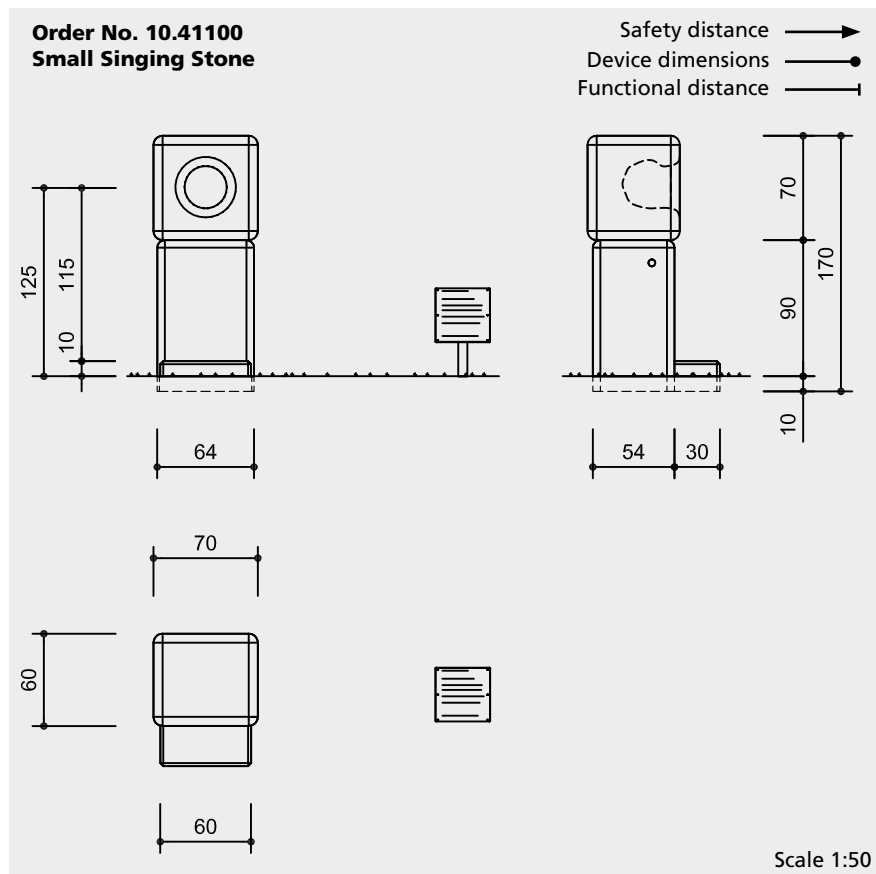

Technical information

Hewn cubic monolithic basalt lava singing stone and pedestal with textured surface and strongly rounded edges

Specially formed cavity (singing hollow) with undercut for optimum resonance effect, with water outlet

Board and support for Explanation Board made of stainless steel

Dimensions

(small deviations possible)

Order No. 10.41100
Small Singing Stone

Height	1.70 m
Height stone	0.70 m
Height step	0.10 m
Width stone	0.60 m
Weight	1440 kg

Order No. 10.41300
Small Singing Stone

Height stone	0.70 m
Width stone	0.60 m
Weight	570 kg

Components

Order No. 10.41100

- 1 Small Singing Stone with 2 anchor irons
- 1 Pedestal
- 1 Step
- 1 Explanation Board with support for dowelling, incl. 4 heavy duty anchors

Order No. 10.41300

- 1 Small Singing Stone with 2 anchor irons
- 1 Explanation Board with support for dowelling, incl. 4 heavy duty anchors

Trademark

30 2005 500 000 Germany
40-0682207 South Korea

Installation information

Recommended space
4.00 x 3.00 m

Foundations

- Order No. 10.41100**
Small Singing Stone
1 item 100 x 80 x 60 cm
Excavation depth 70 cm
Recess 5 x 5 x 20 cm
Explanation Board
1 item 40 x 40 x 40 cm
Excavation depth 60 cm

Attention:
Exact measurements may vary;
for all installation dimensions refer
to current assembly instructions.
Technical changes reserved.

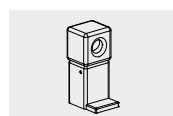

10.41100

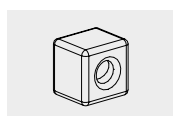

10.41300



Photo © Daniel Perales

Play value

If you put your head into the hollow of this giant stone, which weighs tonnes, and hum different notes, you can retreat into a separate, complete world. You can discover „your“ note where resonance occurs and this causes a gentle sensation throughout your whole body. The organic and striking six to eight sided column shape is like a natural monument, something which is nowadays difficult to find.

Recommended for

- School children
- Young people
- Adults
- Older people
- Supervised play areas such as kindergartens, schools, after-school programmes or similar
- Public play areas without supervision, such as playgrounds, parks or similar

Barrier-free

- Independent play



Large Singing Stone
graubner Play Stations for
 Developing the Senses

Acoustic effect	soft
Vandalism	not vulnerable
Supervision	not necessary
Explanation board	included
Installation	outdoors
Safety check (DIN EN 1176)	not necessary
Installation in concrete	possible



10.42020 / 10.42030 / 10.42040

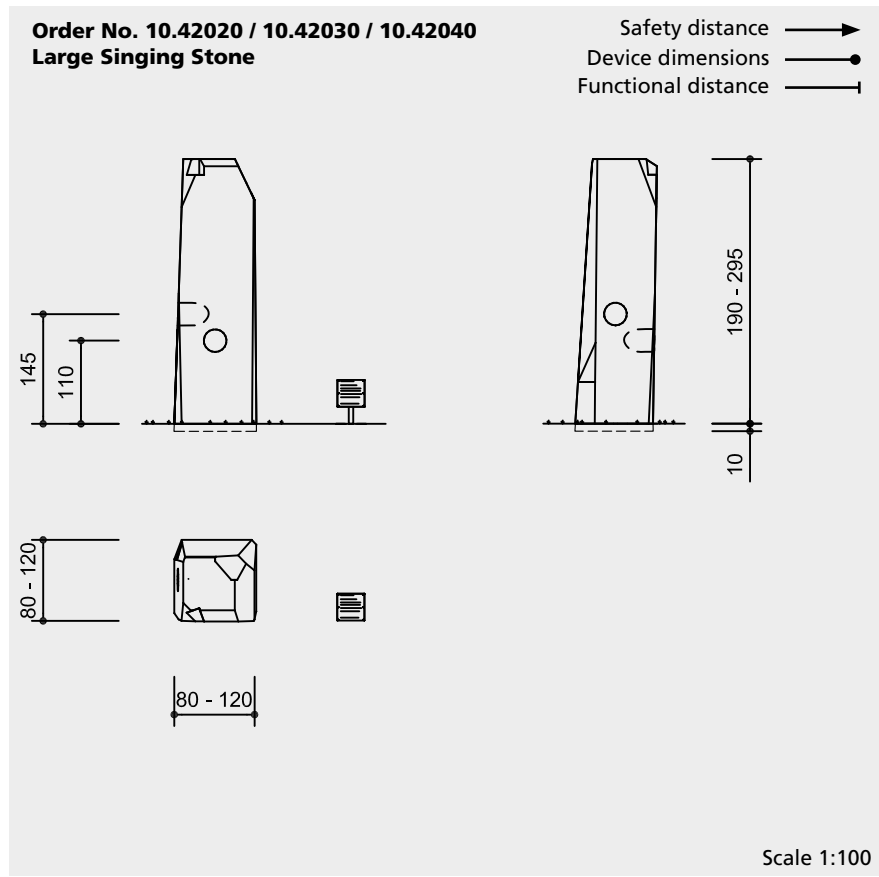

Technical information

Naturally formed basalt column. Each stone has its own individual shape. The side edges haven't been created by a stone mason but have existed in this shape for hundreds of years in stone formations. Traces of water and sediments can be seen clearly.

Specially formed cavities (singing hollows) with undercut for optimum resonance effect, with water outlet

Stable due to a precisely worked base

Board and support for Explanation Board made of stainless steel

Dimensions

(small deviations possible)

Base side of length	0.80 - 1.20 m
Height	
Order No.	
10.42020	2.00 - 2.49 m
10.42030	2.50 - 2.90 m
10.42040	2.91 - 3.05 m
Singing hollows height	1.10 / 1.45 m
Weight depends on size	3 - 8 t

Components

- 1 Large Singing Stone with 2 singing hollows and 1 anchor iron
- 1 Explanation Board with support for dowelling, incl. 4 heavy duty anchors

Trademark

30 2005 500 000 Germany
 40-0682207 South Korea

Installation information

Recommended space
 4.00 x 3.00 m

- Foundations
 1 item 130 x 130 x 70 cm
 Recess 5 x 5 x 50 cm
 Blinding layer
 1 item 130 x 130 x 5 cm
 Total excavation depth 80 cm
- Explanation Board
 1 item 40 x 40 x 40 cm
 Excavation depth 60 cm

Attention:
Exact measurements may vary;
for all installation dimensions refer to current assembly instructions.
 Technical changes reserved.



10.42020 / 10.42030 / 10.42040



Photo © Valentin Luthiger

Play value

It is a well-known fact that, together with the eyes, the ears perceive a great amount of sensory impressions. However, not many of us know how many interesting sounds can be produced by tapping a stone. The ear helps us to „see“ the invisible characteristics of the stone such as hardness, mass and elasticity. Experience of sound is experience of contact. The vibration of the stone is not only conveyed by the eardrum but also via the human skin and - in the case of the Tuning Stone, intensively by the hands. The Tuning Stone is similar to a large tuning fork. The stone has two vertical cuts running down two-thirds of its length, and the split elements can be vibrated. This is achieved by lightly tapping the stone with the flat of the hand or by rubbing the stone firmly with water. This requires a number of attempts and some practice. The participant must achieve an empathy with the stone in order to find the correct frequency, and this enables a special connection to be made with the otherwise cold material.

Recommended for

- School children
- Young people
- Adults
- Older people
- Supervised play areas such as kindergartens, schools, after-school programmes or similar
- Public play areas without supervision, such as playgrounds, parks or similar

Barrier-free

- Independent play

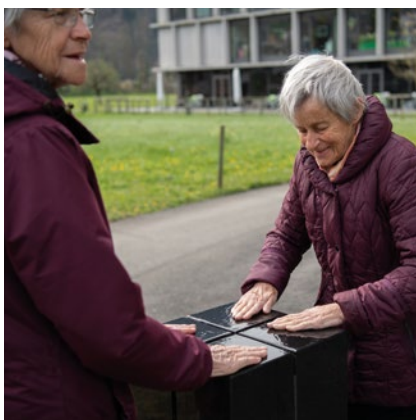
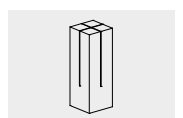

Photo © Valentin Luthiger

Tuning Stone
graubner Play Stations for
 Developing the Senses

Acoustic effect	soft
Vandalism	not vulnerable
Supervision	recommended
Explanation Board	included
Installation	indoors and outdoors
Safety check (DIN EN 1176)	not necessary
Installation in concrete	possible



10.44000

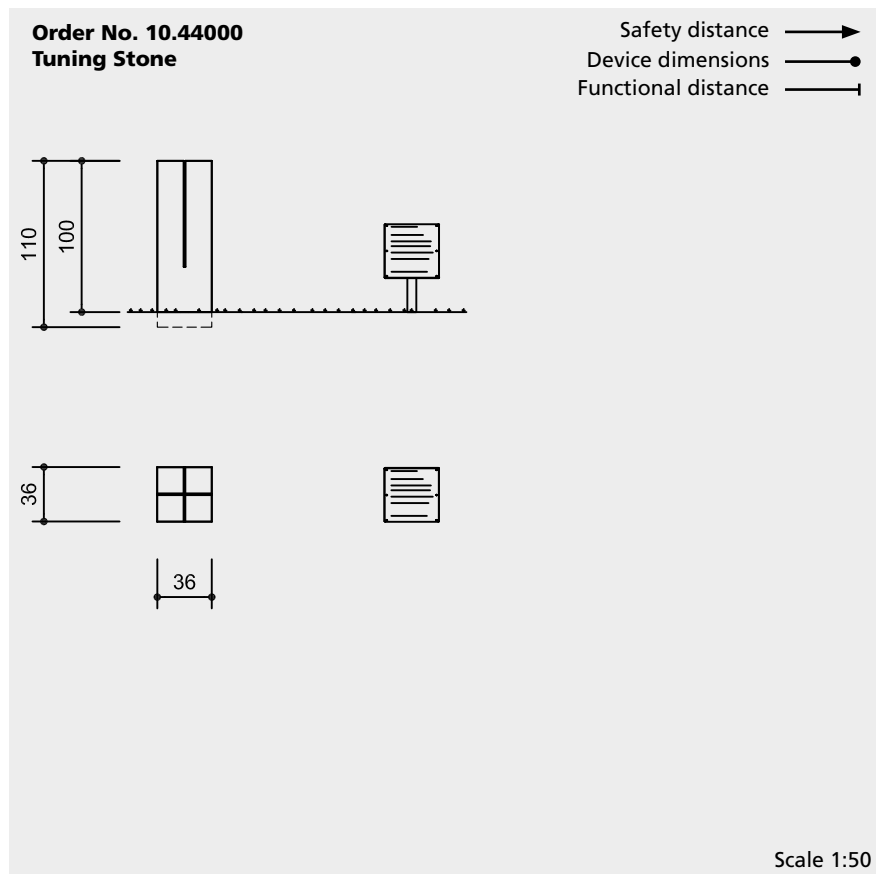

Technical information

Black granite block, polished outer surfaces

A long series of tests was necessary to find a highly dense stone that would produce such a sound phenomenon. The stone blocks are individually chosen, sawn, smoothed and polished.

Board and support for Explanation Board made of stainless steel

Dimensions

(small deviations possible)

Total height	1.10 m
Width	0.36 m
Depth	0.36 m
Weight	440 kg
with packaging material	463 kg

Components

- 1 Tuning Stone with 1 anchor iron
- 1 Explanation Board with support for dowelling, incl. 4 heavy duty anchors

Trademark

30 2005 500 000 Germany
40-0682207 South Korea

Installation information

Recommended space
Circle diameter 3.00 m

- Foundations
- 1 item 80 x 80 x 60 cm
 - Excavation depth 70 cm
 - Recess 5 x 5 x 20 cm
 - Explanation Board
 - 1 item 40 x 40 x 40 cm
 - Excavation depth 60 cm

Attention:

Exact measurements may vary; for all installation dimensions refer to current assembly instructions.

Technical changes reserved.

Tip

Place close to water so that the hands, or rather the stone, can be wetted.

We recommend our Water Dish with stand post (**Order No. 10.44001**).

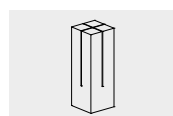

10.44000



Photo © Daniel Perales

Play value

With this stone you can create wonderful notes which resemble the heavenly sounds of a harp. The precisely measured, deep cuts enable the stone to produce a full range of tones. The shorter the cut, the higher the tone. Different notes up to an octave apart can be created.

Recommended for

- School children
- Young people
- Adults
- Supervised play areas such as kindergartens, schools, after-school programmes or similar
- Public play areas without supervision, such as playgrounds, parks or similar
- Swimming pools without supervision, such as outdoor pools, adventure pools or similar

Barrier-free

- Independent play



Photo © Daniel Perales



Photo © Daniel Perales

Stone Harp
graubner Play Stations for
 Developing the Senses

Acoustic effect	soft
Vandalism	slightly vulnerable
Supervision	not necessary
Explanation board	not necessary
Installation	indoors and outdoors
Safety check (DIN EN 1176)	not necessary
Installation in concrete	possible



10.45000



Order No. 10.45000
Stone Harp

Safety distance →
 Device dimensions —●—
 Functional distance —|—

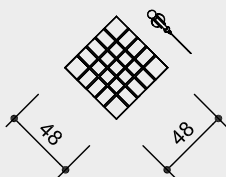
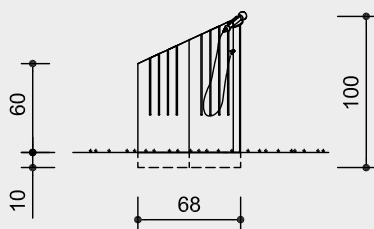
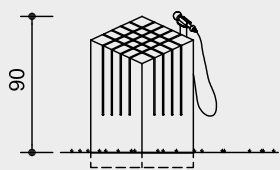

Scale 1:50

Technical information

Highly-dense black granite with polished outer surfaces

The top surface is angled in order to create different sounds, cuts are regularly spaced

Stand post for beater made of stainless steel

Beater of black synthetic material, suspension made of stainless steel cable

Dimensions

(small deviations possible)

Total height	1.00 m
Width	0.48 m
Depth	0.48 m
Weight	600 kg

Components

- 1 Stone Harp with 1 anchor iron
- 1 Beater with stand post for dowelling and attachment, incl. heavy duty anchor

Trademark

30 2005 500 000 Germany
 40-0682207 South Korea

Explanation board on request

Installation information

Recommended space
 3.00 x 3.00 m

Foundations

Stone Harp
 1 item 80 x 80 x 50 cm
 Excavation depth 60 cm
 Recess 5 x 5 x 20 cm

Stand post for beater
 1 item 40 x 40 x 40 cm
 Excavation depth 50 cm

Attention:

Exact measurements may vary; for all installation dimensions refer to current assembly instructions.

Technical changes reserved.



10.45000

Play value

Stones are not mute. Being able to generate a sound from the oversized stones of the giant xylophone is a moving experience. Tapping the solid, heavy granite, marble or volcanic stone with a rubber beater produces a wealth of sounds and harmonies which has an exciting effect on people. Stonemasons recognise stones and their internal characteristics by their sound. Density, hardness and homogeneity of stones are shown during tapping by differing pitch and tonal quality.

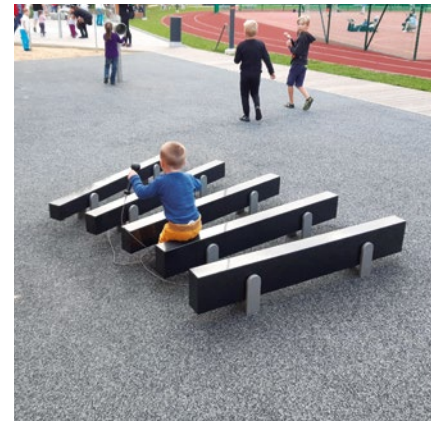

© Richter Spielgeräte GmbH 08/21

The Stone Xylophones are created from specially chosen blocks of black granite. This ensures a high-quality sound and break-resistance.

Recommended for

- School children
- Young people
- Adults
- Supervised play areas such as kindergartens, schools, after school programmes or similar
- Public play areas without supervision such as playgrounds, parks or similar

Barrier-free

- Independent play

Acoustic effect	medium
Vandalism	not vulnerable
Supervision	not necessary
Explanation Board	recommended
Installation	indoors and outdoors
Safety check (DIN EN 1176)	not necessary
Installation in concrete	possible

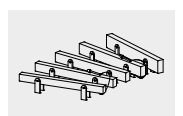

Stone Xylophone
graubner Play Stations for
Developing the Senses



10.46000

Design W. Graubner based on H. Kükelhaus

Order No. 10.46000
Stone Xylophone

Safety distance 
 Device dimensions 
 Functional distance 

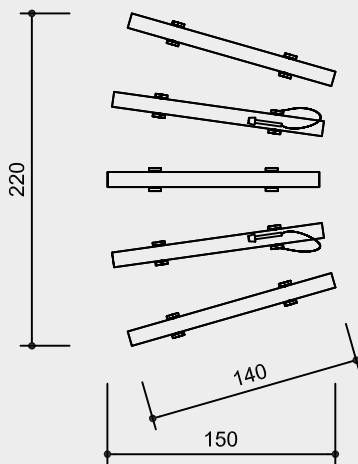

Technical information

The selected granite stones must be very sturdy and yet produce a good sound.

The stones are polished on all sides and tuned to each other.

Beater made of black synthetic material, suspension made of stainless steel cable

Ground anchor

All parts used for anchoring to the ground are made of hot-dip galvanised steel or stainless steel



For more detailed explanation of the quality characteristics see price list.

Dimensions

(small deviations possible)

Height	0.30 m
Length	1.40 m
Width	2.20 m
Weight	490 kg

Scale 1:50

Components

5 Stones with supporting constructions for dowelling and 2 beaters, incl. 12 heavy duty anchors

Trademark

30 2005 500 000 Germany
 40-0682207 South Korea

Explanation board on request

Installation information

Recommended space
 4.00 x 3.00 m

Foundations
 1 item 50 x 250 x 30 cm
 Excavation depth 40 cm
 1 item 40 x 200 x 30 cm
 Excavation depth 40 cm

Attention:
Exact measurements may vary;
for all installation dimensions refer
to current assembly instructions.
 Technical changes reserved.

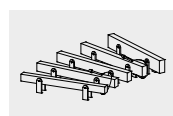

10.46000

Play value

Tone is not just a noise but a sound which the ear perceives as pure and of constant pitch. Each material has its own sound pattern. Metal bars create a particularly high-quality sound if bent into a triangle, and make especially pure vibrations audible. Familiar physical properties are transformed into amazingly simple aspects of life. An increase in the triangle size increases the quantity of upper vibrations clearly and noticeably. It is a learning experience for children and adults and this knowledge reinforces their experiences.

Recommended for

- Kindergarten children
- School children
- Young people
- Adults
- Older people
- Public play areas without supervision, such as playgrounds, parks or similar

Barrier-free

- Independent play



Special version made of stainless steel

Triangles
graubner Play Stations for
 Developing the Senses

Acoustic effect	medium
Vandalism	slightly vulnerable
Supervision	not necessary
Explanation Board	not necessary
Installation	indoors and outdoors
Safety check (DIN EN 1176)	not necessary
Installation in concrete	not necessary



10.52000

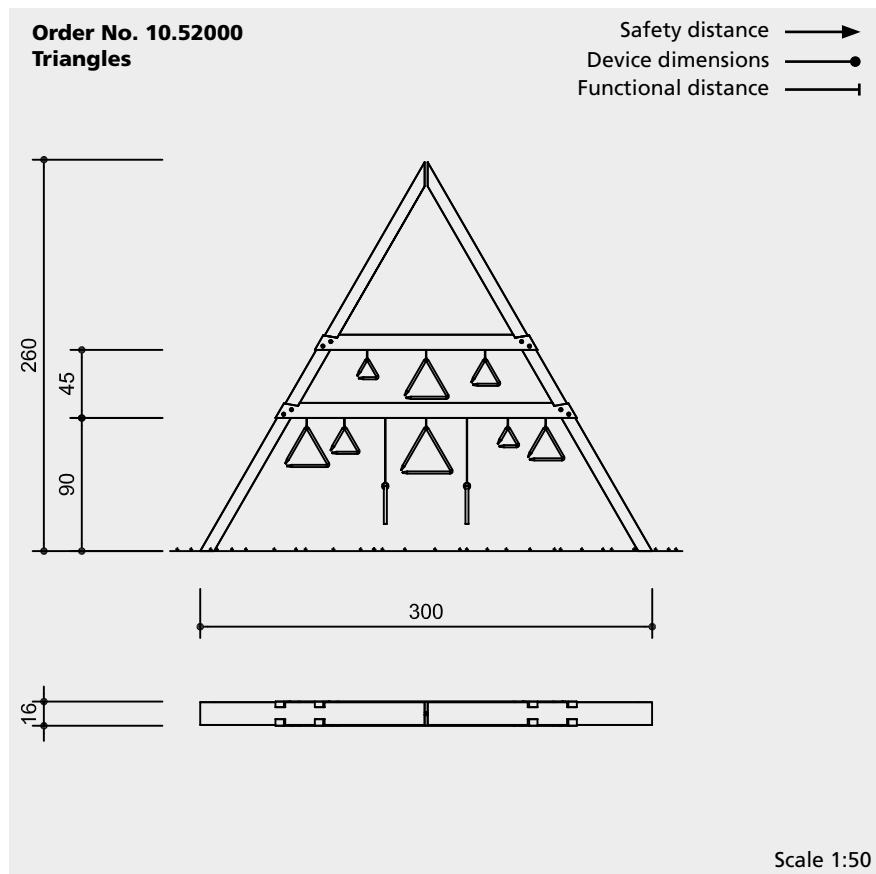

Technical information

Frame made of oak

Core-free

Sawn-timbers core-free, thus decreasing occurrences of cracking and undesired changes in shape



For more detailed explanation of the quality characteristics see price list.

Wooden joints in traditional carpentry quality

Special hardened stainless steel triangles

Beater and cables made of stainless steel

Dimensions

(small deviations possible)

Height	2.60 m
Width	3.00 m
Depth	0.16 m
Weight	100 kg

Components

- 1 Support frame with 8 triangles with 5 different tones and 2 beaters

Trademark

30 2005 500 000 Germany
40-0682207 South Korea

Explanation board on request

Installation information

Recommended space
5.00 x 2.50 m

Foundations
2 items 60 x 40 x 40 cm
Excavation depth 60 cm

Attention:
Exact measurements may vary;
for all installation dimensions refer
to current assembly instructions.
Technical changes reserved.



10.52000



Play value

The skin can also perceive sound. Sound waves, especially those from gongs, are not only perceived by the ear but also by the skin. Every material has its own typical sound. In order to create this sound, the material needs to be made into a typical form. The gong, along with the triangle and bells, is a special design for metal.



Photo © Igral Baikal

Recommended for

- School children
- Young people
- Adults
- Older people
- Supervised play areas such as kindergartens, schools, after school programmes or similar
- Public play areas without supervision such as playgrounds, parks or similar

Barrier-free

- Independent play

Gong
graubner Play Stations
 for Developing the Senses

Acoustic effect	strong; not suitable for residential areas
Vandalism	slightly vulnerable
Supervision	not necessary
Explanation Board	not necessary
Installation	indoors and outdoors
Safety check (DIN EN 1176)	not necessary
Installation in concrete	possible



10.52160



10.52180

Order No. 10.52160
Gong (Diameter 0.60 m)

Safety distance ———→
 Device dimensions ———●
 Functional distance ———|

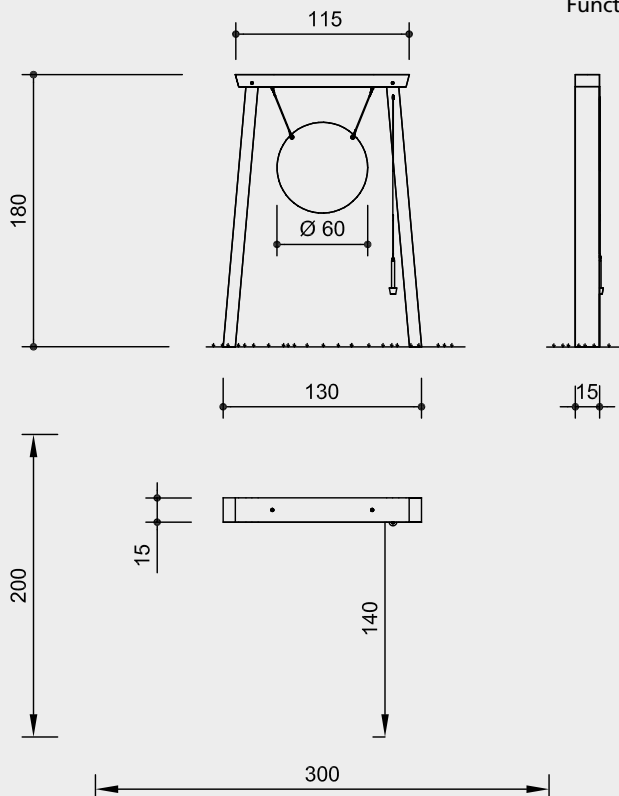

Order No. 10.52180
Gong (Diameter 0.80 m)

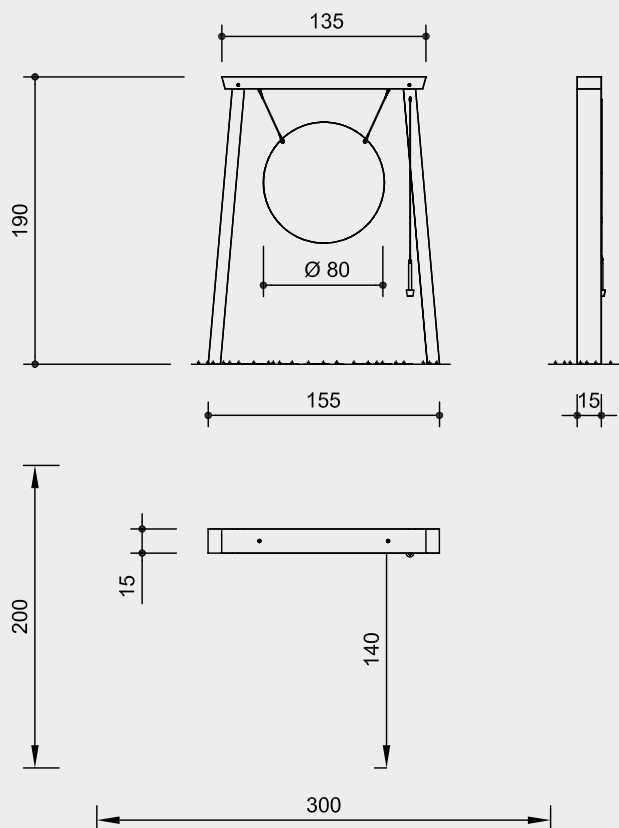

Scale 1:50

Technical information

Frames made of oak

Core-free

Sawn-timbers core-free, thus decreasing occurrences of cracking and undesired changes in shape



For more detailed explanation of the quality characteristics see price list.

Gong made of V2A 4 mm thick with 2 holes for suspension.

Beater with rubber head, suspension made of stainless steel cable

Dimensions

(small deviations possible)

Order No. 10.52160

Height	1.80 m
Width	1.15 / 1.35 m
Depth	0.16 m
Gong diameter	0.60 m
Weight	75 kg

Order No. 10.52180

Height	1.90 m
Width	1.35 / 1.55 m
Depth	0.16 m
Gong diameter	0.80 m
Weight	100 kg

Installation information

Recommended space
 3.00 x 2.00 m

Foundations
 2 items 50 x 50 x 40 cm
 Excavation depth 60 cm

Attention:
Exact measurements may vary;
for all installation dimensions refer
to current assembly instructions.
 Technical changes reserved.

Components

1 Support frame with 1 gong
 and 1 beater

Trademark

30 2005 500 000 Germany
 40-0682207 South Korea

Explanation board on request



10.52160



10.52180



Photo © Daniel Perales

Play value

The force and rhythm with which the Metal Gongs are struck gives rise to different sounds and resonances. Each metal disc produces a particular range of sound. Together they make melodic games and sound experiments possible. There are e.g. calming sounds which find resonance in particular areas of the body, head, neck, chest or stomach, depending on pitch. The type of percussion, with a percussion beater or by hand, produces sounds which generate melodic patterns and rhythms. Several people can play simultaneously and create music by listening to each other.

Recommended for

- Kindergarten children
- School children
- Young people
- Adults
- Older people
- Supervised play areas, such as kindergartens, schools, after-school programmes or similar
- Public play areas without supervision, such as playgrounds, parks or similar

Barrier-free

- Independent play



Photo © Daniel Perales



Photo © Daniel Perales

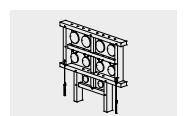

Metal Gongs
graubner Play Stations for
 Developing the Senses

Acoustic effect	soft
Vandalism	slightly vulnerable
Supervision	not necessary
Explanation Board	not necessary
Installation	indoors and outdoors
Safety check (DIN EN 1176)	not necessary
Installation in concrete	possible



10.52200

Order No. 10.52200
Metal Gongs

Safety distance 
 Device dimensions 
 Functional distance 

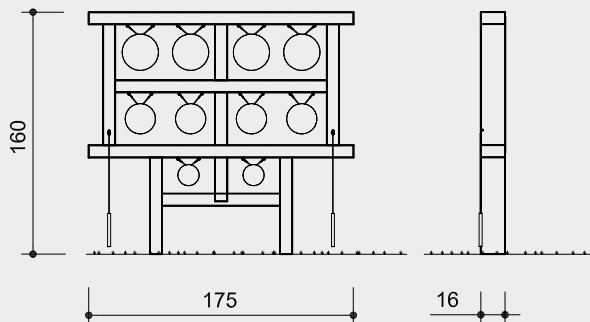

Scale 1:50

Technical information

Frame made of oak

Core-free

Sawn-timbers core-free, thus decreasing occurrences of cracking and undesired changes in shape



For more detailed explanation of the quality characteristics see price list.

High-quality metal discs in brass, suspension made of stainless steel cable

Beater made of white synthetic material, suspension made of stainless steel cable

Dimensions

(small deviations possible)

Height	1.60 m
Width	1.75 m
Depth	0.16 m
Weight	120 kg

Components

- 1 Support frame with 10 metal discs and 2 beaters

Trademark

30 2005 500 000 Germany
 40-0682207 South Korea

Explanation board on request

Installation information

Recommended space
 3.00 x 2.00 m

Foundations
 1 item 150 x 60 x 55 cm
 Excavation depth 75 cm

Attention:
Exact measurements may vary;
for all installation dimensions refer
to current assembly instructions.
 Technical changes reserved.
Equipment also available with steel
feet.

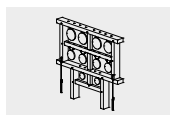

10.52200



Play value

Just like a harp, you can pluck the strings and create harmonic, relatively deep and long-lasting multiphonic notes. The vibration of the strings and the ensuing sound can literally be seen with the eyes. The spectrum of notes extends over a complete octave. The tensioned stainless steel plate makes the tensile force created by the nine strings visual and has the effect of amplifying the sound.

Recommended for

- School children
- Young people
- Adults
- Older people
- Public play areas without supervision, such as playgrounds, parks or similar

Barrier-free

- Independent play

Note

To achieve a good sound quality, this equipment must be tuned after installation and the pitch must be checked at regular intervals.

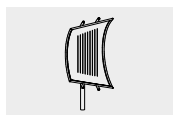

Acoustic effect	soft
Vandalism	vulnerable in non-supervised areas
Supervision	not necessary
Explanation Board	not necessary
Installation	indoors and outdoors
Safety check (DIN EN 1176)	not necessary
Installation in concrete	possible

Sound Chord
graubner Play Stations for
 Developing the Senses



10.52300

Order No. 10.52300
Sound Chord

Safety distance 
Device dimensions 
Functional distance 

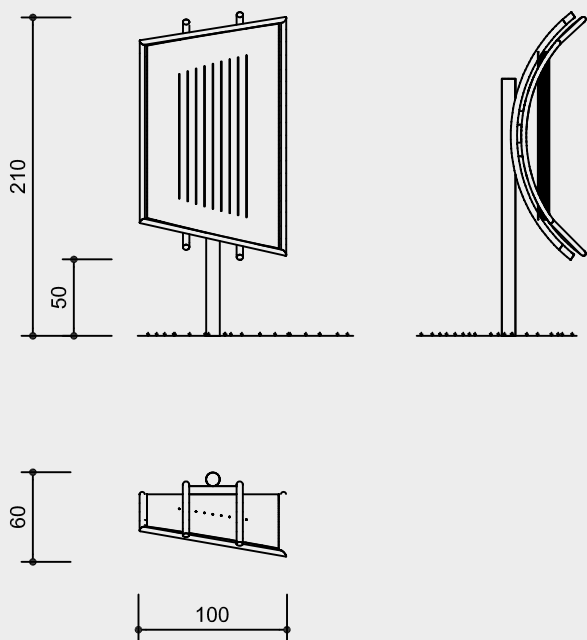

Scale 1:50

Technical information

Equipment and strings made of stainless steel

Ground anchor

All parts used for anchoring to the ground are made of hot-dip galvanised steel or stainless steel



For more detailed explanation of the quality characteristics see price list.

Dimensions

(small deviations possible)

Height	2.10 m
Width	1.00 m
Depth	0.60 m
Weight	120 kg

Components

- 1 Complete piece of equipment with 9 strings, for dowelling, incl. 4 heavy duty anchors

Trademark

30 2005 500 000 Germany
40-0682207 South Korea

Explanation board on request

Installation information

Recommended space
2.50 x 2.00 m

Foundations
1 item 60 x 60 x 50 cm
Excavation depth 70 cm

Attention:

Exact measurements may vary; for all installation dimensions refer to current assembly instructions.

Technical changes reserved.



10.52300



Play value

If the respective shape and alloy is used for metal pipes to create the perfect sound then they are called Tubular Chimes. They have been specially tuned for optimal sound with 1 major and 1 minor note around a common central note. Tubular Chimes are, like other orchestral instruments, tuned precisely. No other instrument can produce such a fine and lasting sound.

Recommended for

- Kindergarten children
- School children
- Young people
- Adults
- Older people
- Public play areas without supervision, such as playgrounds, parks or similar

Barrier-free

- Independent play



Tubular Chimes
graubner Play Stations
 for Developing the Senses

Acoustic effect	medium to strong
Vandalism	slightly vulnerable
Supervision	not necessary
Explanation Board	not necessary
Installation	indoors and outdoors
Safety check (DIN EN 1176)	not necessary
Installation in concrete	possible



10.52400

Order No. 10.52400
Tubular Chimes

Safety distance 
 Device dimensions 
 Functional distance 

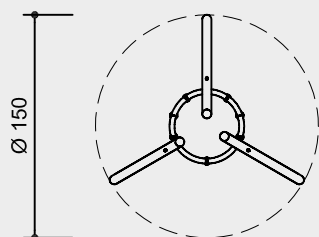
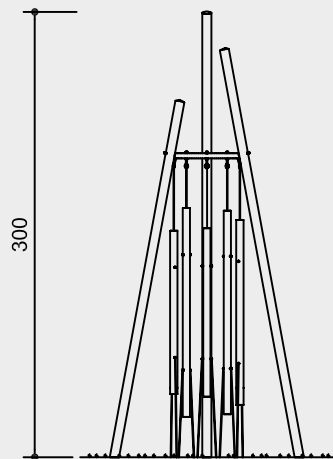

Scale 1:50

Technical information

Supporting tubes, ring, foot plates and base plate made of stainless steel

Ground anchor

All parts used for anchoring to the ground are made of hot-dip galvanised steel or stainless steel



For more detailed explanation of the quality characteristics see price list.

Tuned brass sound tubes

Tensioning cable made of stainless steel

Beater made of plastic, suspension made of stainless steel cable

Dimensions

(small deviations possible)

Height	3.00 m
Diameter	1.50 m
Sound tubes diameter	48 x 4 mm
Weight	90 kg

Components

- 3 Supporting tubes on foot plates for dowelling
- 1 Ring with 5 sound tubes and tensioning cables on base plate, each to be screwed in, incl. 14 heavy duty anchors
- 2 Beaters

Trademark

30 2005 500 000 Germany
 40-0682207 South Korea

Explanation board on request

Installation information

Recommended space
 Circle diameter 3.00 m

Foundations
 1 item triangular,
 Length of the edge 175 cm,
 20 cm high,
 Excavation depth 30 cm

Attention:
Exact measurements may vary;
for all installation dimensions refer to current assembly instructions.

Technical changes reserved.



10.52400

© Richter Spielgeräte GmbH 08/21

Play value

Eddy currents which can be observed in water can also be found in a similar form in the air. These invisible phenomena are transformed into a soft heavenly sound by the Wind Harp which is also called the Aeolian Harp. Air is not only the carrier for the sound, but the air vortexes themselves produce sounds. The Aeolian Harp is a stringed instrument resembling a trapezoidal zither which is referred to in many ancient songs and tales. The instrument is turned into the direction of the wind so that it produces sounds. It is a particularly interesting aspect that when the wind is stronger more overtones are produced.

Recommended for

- School children
- Young people
- Adults
- Older people
- Public play areas without supervision, such as playgrounds, parks or similar

Barrier-free

- Independent play



Special version

Wind Harp
graubner Play Stations
for Developing the Senses

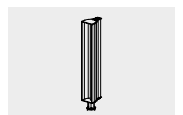

Acoustic effect	strong in wind; not suitable for residential areas
Vandalism	not vulnerable
Supervision	not necessary
Explanation Board	included
Installation	outdoors
Safety check (DIN EN 1176)	not necessary
Installation in concrete	possible



10.52500

Design W. Graubner

Order No. 10.52500
Wind Harp

Safety distance 
Device dimensions 
Functional distance 

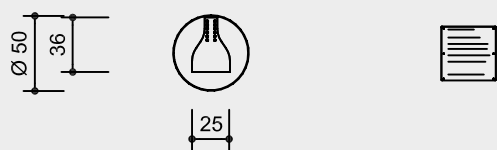
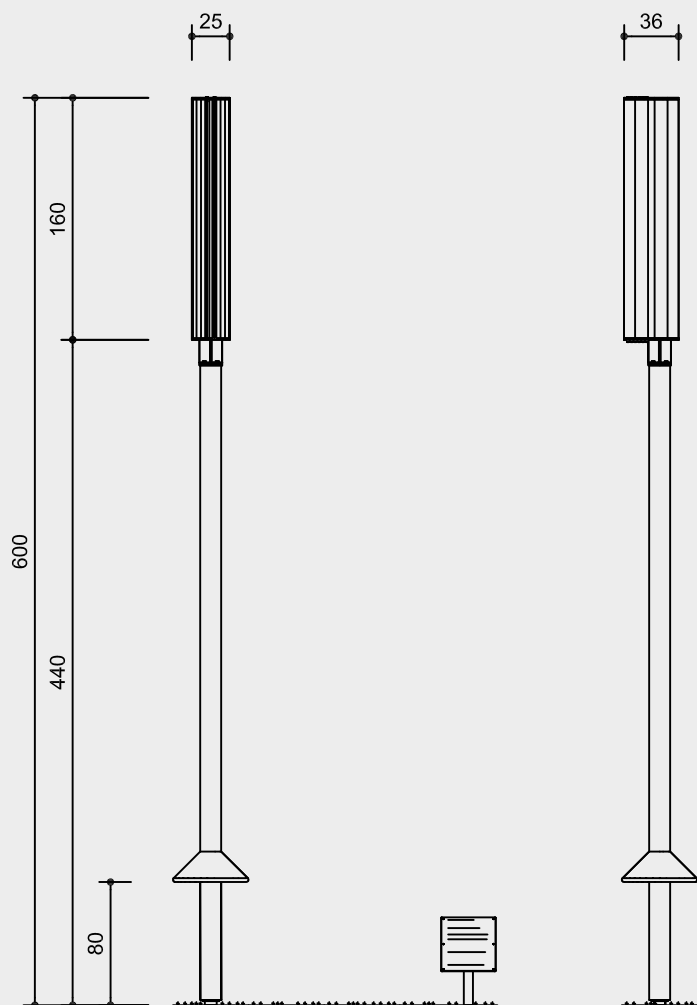

Technical information

Rotating, stainless steel mast, with ball bearings for turning the wind harp into the wind direction

Resonance body made of stainless steel supported on bearings with air baffles to improve the air flow and with a resonance effect for the vibrations produced

Ground anchor

All parts used for anchoring to the ground are made of hot-dip galvanised steel or stainless steel



Roller bearings

Roller bearings made of stainless steel for rotating elements, easy to maintain and exchange, sealed



For more detailed explanation of the quality characteristics see price list.

Resonance body with 12 strings

Support for Explanation Board made of stainless steel

Dimensions

(small deviations possible)

Total height	6.00 m
Resonance body	1.60 x 0.25 x 0.36 m
Weight	200 kg

Components

- 1 Complete piece of equipment with steel mast and foundation anchor
- 1 Explanation Board with support for dowelling, incl. 4 heavy duty anchors

Trademark

30 2005 500 000 Germany
40-0682207 South Korea

Installation information

Recommended space
Circle diameter 3.00 m

- Foundations
- 1 item 130 x 130 x 70 cm, reinforced
 - Blinding layer 5 cm
 - Excavation depth 115 cm
- Explanation Board
- 1 item 40 x 40 x 40 cm
 - Excavation depth 60 cm

Attention:
Exact measurements may vary;
for all installation dimensions refer to current assembly instructions.
Technical changes reserved.

Scale 1:50

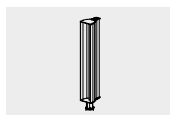

10.52500



Photo © Daniel Perales

Play value

The Dendrophone is made up of harmoniously tuned sound boards which have been arranged like an oversized xylophone. If the lengths of the sound elements are changed different tones are produced and these are tuned and amplified with resonators. Hitting it, either with a percussion beater or by hand, produces warm sounds and these can be made into melodies and rhythms. Several people can play on the equipment at the same time and create music together.

Recommended for

- Kindergarten children
- School children
- Young people
- Adults
- Public play areas without supervision such as playgrounds, parks or similar

Barrier-free

- Independent play



Order No. 10.53002 Dendrophone - double field, Photo © Daniel Perales



Photo © Daniel Perales

Dendrophone - single field
Dendrophone - double field
graubner Play Stations
 for Developing the Senses

Acoustic effect	soft
Vandalism	slightly vulnerable
Supervision	not necessary
Explanation Board	not necessary
Installation	indoors and outdoors
Safety check (DIN EN 1176)	not necessary
Installation in concrete	possible



10.53000



10.53002

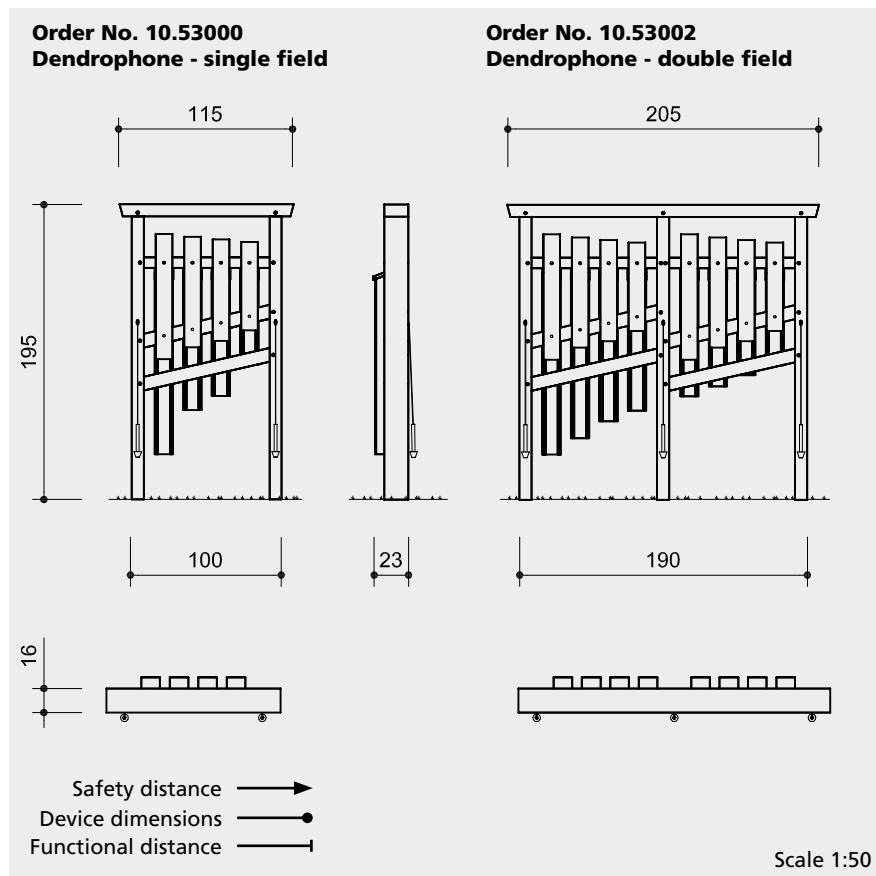

Technical information

Frame made of oak

Core-free

Sawn-timbers core-free, thus decreasing occurrences of cracking and undesired changes in shape



For more detailed explanation of the quality characteristics see price list.

Carefully chosen tuned sound boards made of cherry wood

The vertical resonators are designed to create optimal sound with each sound board

Only wood joints in accordance with traditional carpentry

Beater with rubber head, suspension made of stainless steel cable

Dimensions

(small deviations possible)

Order No. 10.53000
Dendrophone - single field

Height	1.95 m
Width	1.15 / 1.00 m
Depth	0.23 m
Weight	75 kg

Order No. 10.53002
Dendrophone - double field

Height	1.95 m
Width	2.05 / 1.90 m
Depth	0.23 m
Weight	140 kg

Components

Order No. 10.53000

1 Single field with 4 sound boards and 2 beaters

Order No. 10.53002

1 Double field with 8 sound boards and 3 beaters

Trademark

30 2005 500 000 Germany
40-0682207 South Korea

Explanation board on request

Installation information

Recommended space

Dendrophone - single field
2.50 x 2.10 m

Dendrophone - double field
2.50 x 3.00 m

Foundations

Order No. 10.53000

Dendrophone - single field

2 items 40 x 40 x 40 cm
Excavation depth 60 cm

Order No. 10.53002

Dendrophone - double field

3 items 40 x 40 x 40 cm
Excavation depth 60 cm

Attention:

Exact measurements may vary; for all installation dimensions refer to current assembly instructions.

Technical changes reserved.

Equipment also available with steel feet.



10.53000



10.53002



Order No. 10.53102 Tubular Dendrophone - double field



Order No. 10.53100 Tubular Dendrophone - single field

Play value

The Tubular Dendrophone creates music to listen to and feel, with harmoniously tuned wooden pipes which are both sound and resonance elements. If you place your hand on a ringing sound pipe it sends the vibration of the wood through your body. The sound of the wood combines with the resonance of the enclosed air in the pipes.

Recommended for

- Kindergarten children
- School children
- Young people
- Adults
- Older people
- Supervised play areas such as kindergartens, schools, after school programmes or similar
- Public play areas without supervision such as playgrounds, parks or similar

Barrier-free

- Independent play



Special version

**Tubular Dendrophone - single field
Tubular Dendrophone - double field**

graubner Play Stations
for Developing the Senses

Acoustic effect	soft
Vandalism	slightly vulnerable
Supervision	not necessary
Explanation Board	not necessary
Installation	indoors and outdoors
Safety check (DIN EN 1176)	not necessary
Installation in concrete	possible



10.53100



10.53102

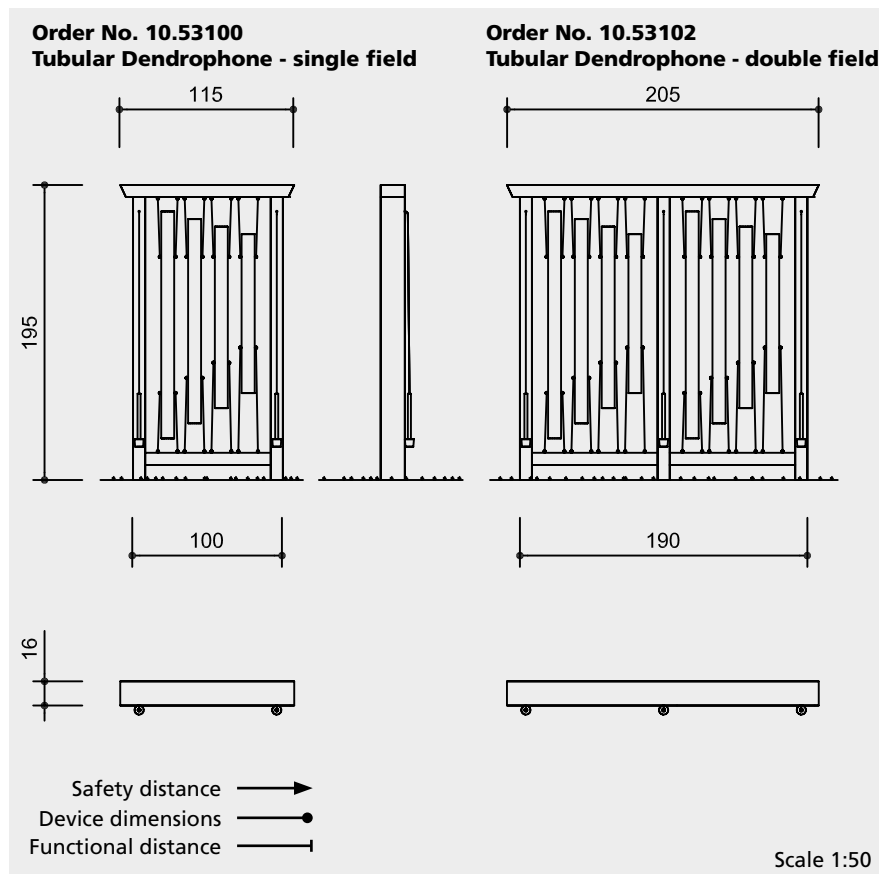

Technical information

Frame made of oak

Core-free

Sawn-timbers core-free, thus decreasing occurrences of cracking and undesired changes in shape



For more detailed explanation of the quality characteristics see price list.

Binary sound tubes of milled and turned cherry wood bonded together

Special suspension with low vibration absorption made of stainless steel and brass

Beater with rubber head, suspension on a stainless steel cable

Dimensions

(small deviations possible)

Order No. 10.53100

Tubular Dendrophone - single field

Height	1.95 m
Width	1.15 / 1.00 m
Depth	0.16 m
Weight	85 kg

Order No. 10.53102

Tubular Dendrophone - double field

Height	1.95 m
Width	2.05 / 1.90 m
Depth	0.16 m
Weight	160 kg

Components

Order No. 10.53100

- 1 Single field with 4 sound tubes and 2 beaters

Order No. 10.53102

- 1 Double field with 8 sound tubes and 3 beaters

Trademark

30 2005 500 000 Germany
40-0682207 South Korea

Explanation board on request

Installation information

Recommended space

Tubular Dendrophone - single field

2.50 x 2.10 m

Tubular Dendrophone - double field

3.00 x 2.50 m

Foundations

Order No. 10.53100

Tubular Dendrophone - single field

2 items 40 x 40 x 40 cm

Excavation depth 60 cm

Order No. 10.53102

Tubular Dendrophone - double field

3 items 40 x 40 x 40 cm

Excavation depth 60 cm

Attention:

Exact measurements may vary; for all installation dimensions refer to current assembly instructions.

Technical changes reserved.

Equipment also available with steel feet.



10.53100



10.53102



Play value

The Sound Arch which consists of 5 wooden sound tubes can be played from both sides at the same time. This has the effect of particularly encouraging the participants to play together and listen to each other.

Recommended for

- Kindergarten children
- School children
- Young people
- Adults
- Older people
- Supervised play areas such as kindergartens, schools, after school programmes or similar
- Public play areas without supervision such as playgrounds, parks or similar

Barrier-free

- Independent play

Sound Arch
graubner Play Stations
 for Developing the Senses

Acoustic effect	soft
Vandalism	slightly vulnerable
Supervision	not necessary
Explanation Board	not necessary
Installation	indoors and outdoors
Safety check (DIN EN 1176)	not necessary
Installation in concrete	possible



10.53200

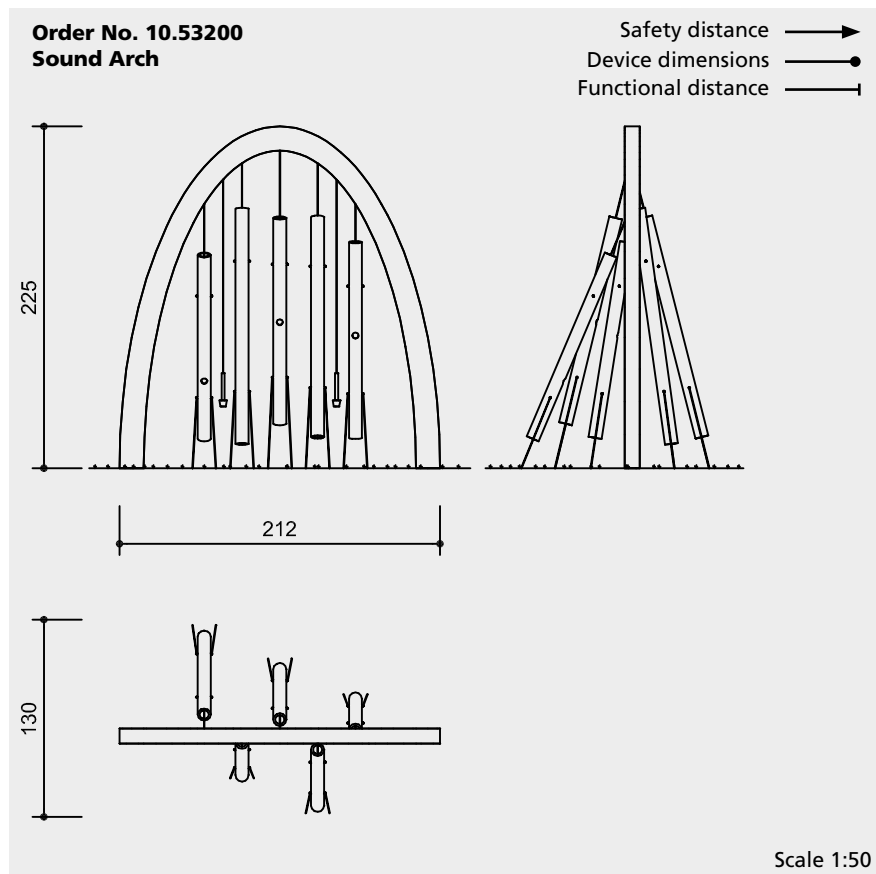

Technical information

Core-free

Sawn-timbers core-free, thus decreasing occurrences of cracking and undesired changes in shape



Ground anchor

All parts used for anchoring to the ground are made of hot-dip galvanised steel or stainless steel



For more detailed explanation of the quality characteristics see price list.

Binary sound tubes of milled and turned cherry wood bonded together

Special suspension with low vibration absorption made of stainless steel and brass

Beater with rubber head, suspension made of stainless steel cable

Dimensions

(small deviations possible)

Height	2.25 m
Width	2.12 m
Depth	1.30 m
Weight	110 kg

Components

- 1 Wooden bow with steel feet for dowelling
- 5 Sound tubes with tensioning cables and base plates for dowelling each, incl. 18 heavy duty anchors
- 2 Beaters

Trademark

30 2005 500 000 Germany
40-0682207 South Korea

Explanation board on request

Installation information

Recommended space
4.50 x 3.00 m

- Foundations**
- 2 items 50 x 50 x 50 cm
Excavation depth 70 cm
 - 1 item 175 x 30 x 30 cm
Excavation depth 45 cm
 - 1 item 100 x 30 x 30 cm
Excavation depth 50 cm

Attention:
Exact measurements may vary;
for all installation dimensions refer
to current assembly instructions.

Technical changes reserved.



10.53200

Play value

These stylised tree shapes with their different sound leaves, sound branches and drums are particularly suited to parks and atmospheric gardens. Exciting music can be experienced when played together. The sounds range from the melancholic sound of the Steeldrum to the cheerful one of the Sound Leaf. These robust objects can be played by hand or with the attached hammers.

Sound Leaf

The individual sound plates have a tone like the clang of a cymbal. The stylised leaves are attached to the tree in a way that they can move freely. They produce a very cheerful and lively sound.

Sound Tree

The sound bars are like powerful chimes and represent branches. They are also used to make xylophones.

Steeldrum

The melodic, sometimes also melancholic sound of the Steeldrum fascinates people. It symbolises the wooden drums that are made from hollowed tree trunks in many different cultures. The Steeldrum was first made from old oil barrels after the Second World War by people from the Caribbean. Skilful hammering creates individual areas in the base each having their own different tone.

Recommended for

- School children
- Young people
- Adults
- Older people
- Public play areas without supervision, such as playgrounds, parks or similar



Order No. 10.54100 Sound Tree

**Sound Leaf
Sound Tree
Steeldrum**
graubner Play Stations
for Developing the Senses



Order No. 10.54100 Sound Tree

Acoustic effect	medium
Vandalism	not vulnerable
Supervision	not necessary
Explanation Board	not necessary
Installation	outdoors
Safety check (DIN EN 1176)	not necessary
Installation in concrete	not possible



10.54000

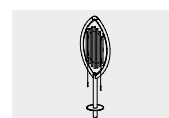

10.54100

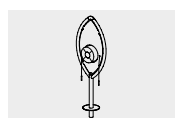

10.54200

© Richter Spielgeräte GmbH 08/21

Design M. Schedlbauer / W. Graubner

Order No. 10.54000
Sound Leaf

Safety distance →
Device dimensions ●—
Functional distance —|

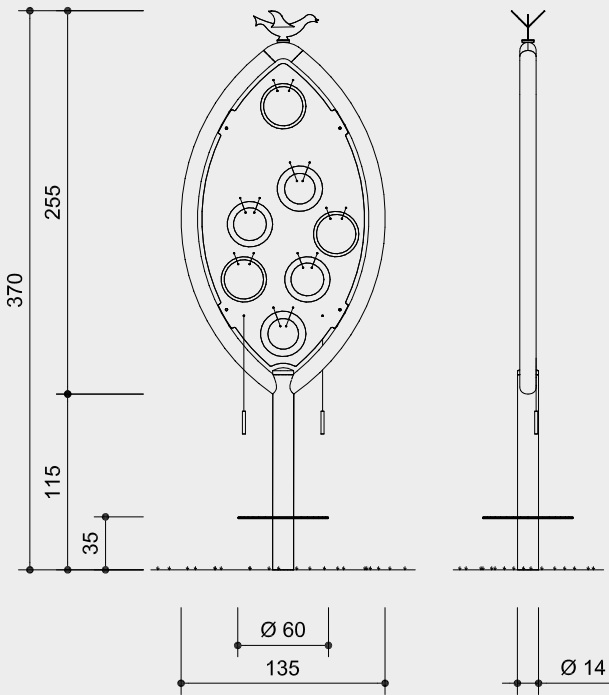

Order No. 10.54100
Sound Tree

Order No. 10.54200
Steeldrum

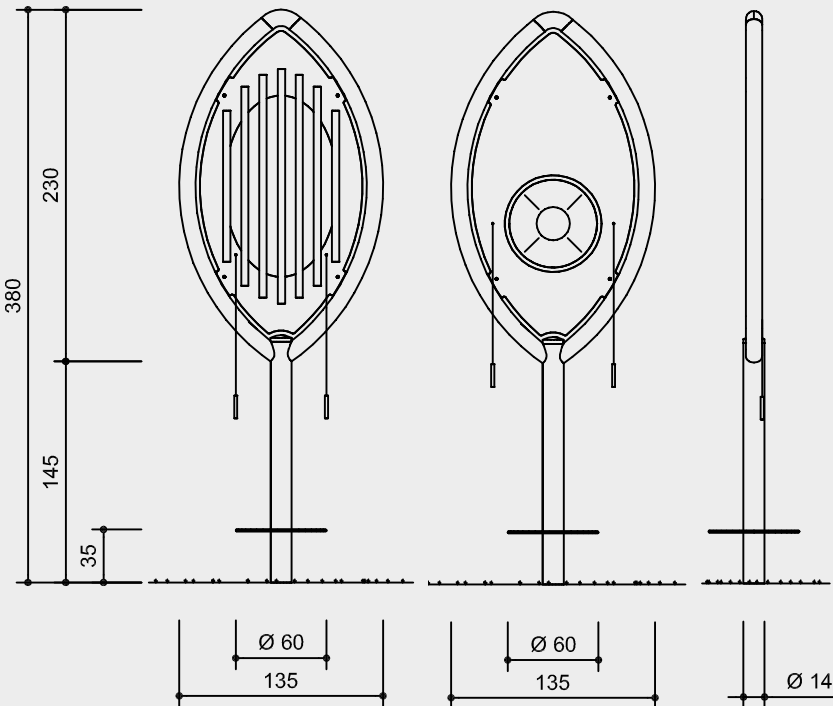

Scale 1:50

Technical information

Equipment made of stainless steel;
in stylized tree shape

Ground anchor

All parts used for anchoring to the
ground are made of hot-dip galvanised
steel or stainless steel



**For more detailed explanation of the
quality characteristics see price list.**

Order No. 10.54000
Sound Leaf

Sound plates made of brass
Beater made of PE

Order No. 10.54100
Sound Tree

Tubes made of brass
Beater made of PE

Order No. 10.54200
Steeldrum

Meditation pan made of stainless steel
Powder-coated
Beater made of rubber

Dimensions

(small deviations possible)

Order No. 10.54000
Sound Leaf

Height	3.70 m
Headroom	0.35 m
Width	1.35 m
Weight	180 kg

Order No. 10.54100
Sound Tree

Order No. 10.54200
Steeldrum

Height	3.80 m
Headroom	0.35 m
Width	1.35 m
Weight	180 kg

Components

- 1 Complete piece of equipment
with Foundation frame

Trademark

30 2005 500 000 Germany
40-0682207 South Korea

Explanation board on request

Installation information

Recommended space
Circle diameter 3.00 m

Foundation
1 item 130 x 130 x 70 cm
reinforced
Blinding layer
130 x 130 x 5 cm
Total excavation depth 115 cm

Attention:

**Exact measurements may vary;
for all installation dimensions refer
to current assembly instructions.**

Technical changes reserved.



10.54000

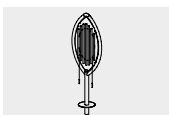

10.54100

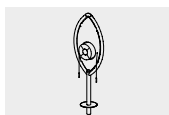

10.54200



Order No. 10.57200 Listening to Water as Pillar

Play value

We recommend installing a play station at the start of educational water trails, fields of experience, and also in entrances to playgrounds, where they serve the purpose of preparing the arriving participant for the following sensory and perceptual experiences. The play station „Listening to Water“ is suitable for this purpose. With this installation visitors are introduced to the natural sounds coming from a watercourse: dripping, murmuring, gurgling.

Recommended for

- School children
- Young people
- Adults
- Older people
- Public play areas without supervision, such as playgrounds, parks or similar

Barrier-free

- Independent play



Order No. 10.57100 Listening to Water



Order No. 10.57100 Listening to Water

Listening to Water
Listening to Water as Pillar
graubner Play Stations
 for Developing the Senses

Acoustic effect	soft
Vandalism	not vulnerable
Supervision	not necessary
Explanation Board	recommended
Installation	outdoors
Safety check (DIN EN 1176)	not necessary
Installation in concrete	not possible

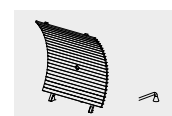

10.57100



10.57200

© Richter Spielgeräte GmbH 08/21

Design W. Graubner

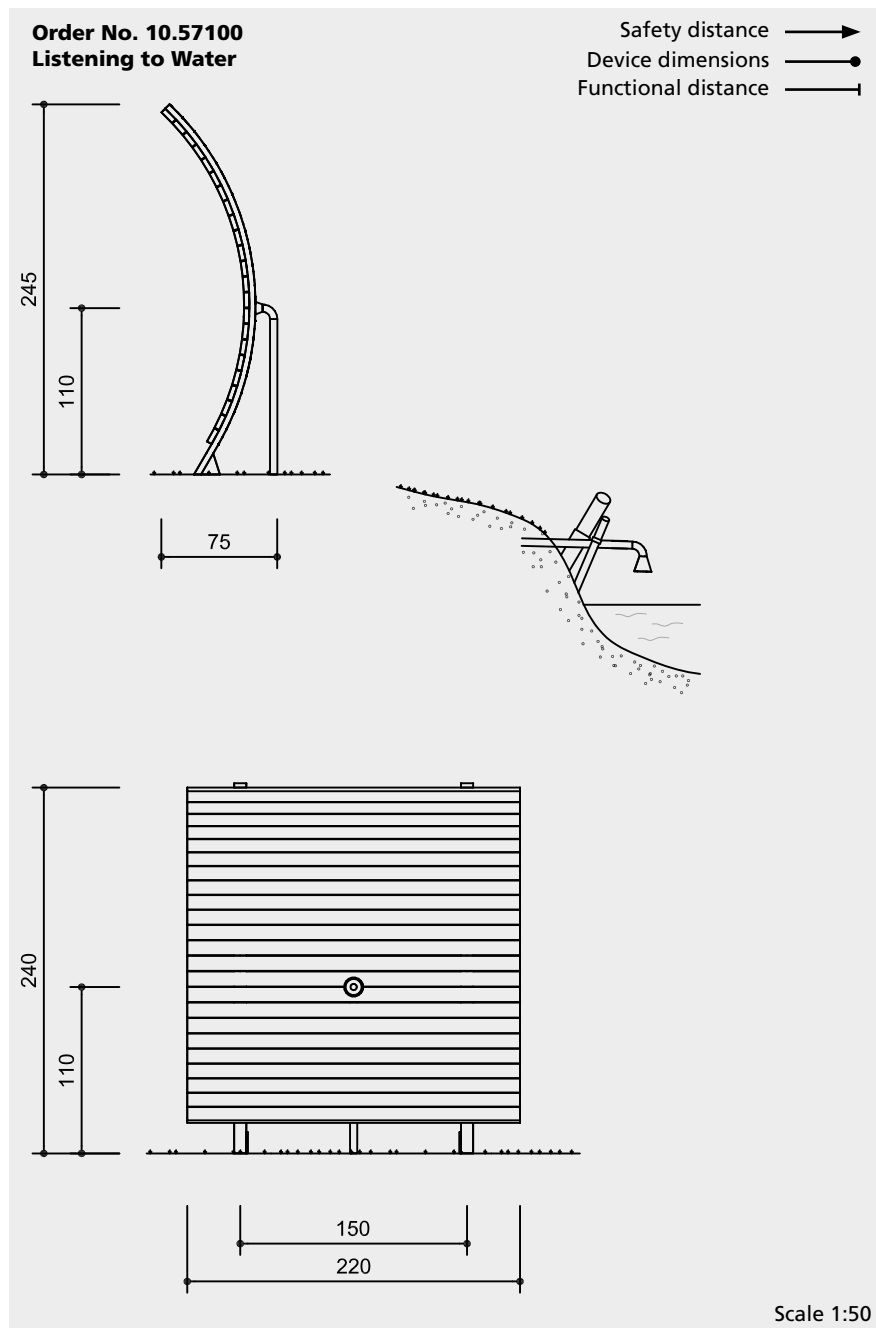

Technical information

Planking made of non-impregnated mountain larch

Core-free

Sawn-timbers core-free, thus decreasing occurrences of cracking and undesired changes in shape



Ground anchor

All parts used for anchoring to the ground are made of hot-dip galvanised steel or stainless steel



For more detailed explanation of the quality characteristics see price list.

All pipe and cone elements as well as pillar made of stainless steel

Hot-dip galvanised frame

Dimensions

(small deviations possible)

Order No. 10.57100 / 10.57200

Height	2.45 m
Listening height	1.10 m
Width	2.20 m
Depth	0.75 m
Weight	260 / 80 kg

Installation information

Recommended space
Depending on the installation situation

Foundations

Order No. 10.57100

Listening to Water

1 item 200 x 100 x 30 cm
Excavation depth 50 cm

Order No. 10.57200

Listening to Water as Pillar

1 item 60 x 60 x 70 cm
Excavation depth 90 cm

Attention:

Exact measurements may vary; for all installation dimensions refer to current assembly instructions.

Technical changes reserved.

Components

Order No. 10.57100

- 1 Reflecting wall with listening cone
- 1 Sound receiving cone for dowelling incl. fastening material and 8 heavy duty anchors

Order No. 10.57200

- 1 Listening pillar
- 1 Sound receiving cone for dowelling incl. fastening material and 4 heavy duty anchors

Trademark

30 2005 500 000 Germany
40-0682207 South Korea

On-site work

Supply and installation of the required pipe work according to our specifications

Explanation board on request

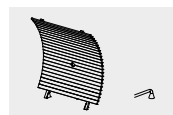

10.57100

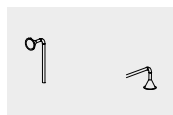

10.57200



Play value

Every culture has its melodies which stay alive by frequent repetition. The melodic fence gives you this opportunity to play these melodies as a chorus or as a canon or even backwards if you want to. The fence has been tuned with little familiar melodies such as „Frère Jacques“. Other melodies within an octave tone range are possible. The melodic fence consists of handrail, frame and sound tubes. Running a hammer or a stick over the metal rods of the melodic fence creates the tune of a song. In non-public areas the suspension can be done with cables instead of a screw. The length of the fence can be varied depending on the melody or the required space.

Recommended for

- Kindergarten children
- School children
- Young people
- Adults
- Older people
- Public play areas without supervision, such as playgrounds, parks or similar

Barrier-free

- Independent play



Melodic Fence „Hänschen Klein“
Melodic Fence „Frère Jacques“
graubner Play Stations
 for Developing the Senses

Acoustic effect	soft
Vandalism	not vulnerable
Supervision	not necessary
Explanation Board	included
Installation	indoors and outdoors
Safety check (DIN EN 1176)	not necessary
Installation in concrete	possible

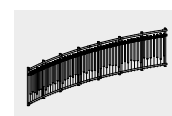

10.58000



10.58100

© Richter Spielgeräte GmbH 08/21

Design W. Graubner

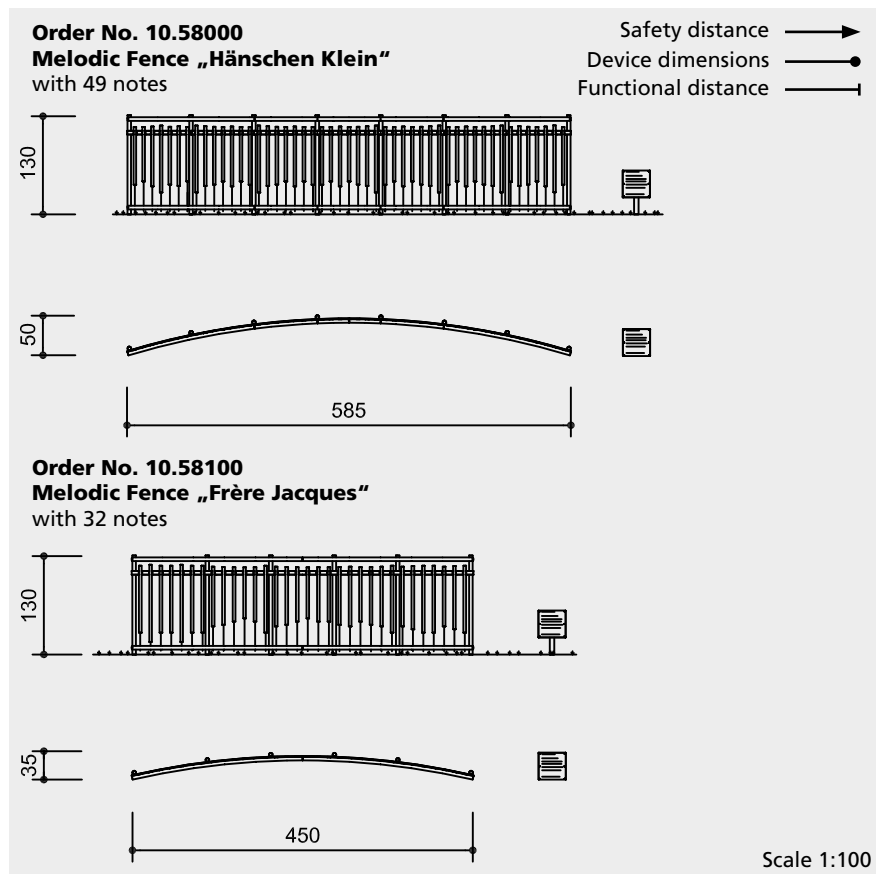

Technical information

Equipment made of stainless steel

Ground anchor

All parts used for anchoring to the ground are made of hot-dip galvanised steel or stainless steel



For more detailed explanation of the quality characteristics see price list.

Board and support for Explanation Board made of stainless steel

Dimensions

(small deviations possible)

Order No. 10.58000

Melodic Fence „Hänschen Klein“

Height	1.30 m
Length	5.85 m
Weight	170 kg

Order No. 10.58100

Melodic Fence „Frère Jacques“

Height	1.30 m
Length	4.50 m
Weight	118 kg

Components

- 1 Complete piece of equipment with base plates for dowelling, incl. fastening material and 16 heavy duty anchors
- 1 Explanation Board with support, incl. 4 heavy duty anchors

Trademark

30 2005 500 000 Germany
40-0682207 South Korea

Installation information

Recommended space
4.80 or 6.00 x 2.00 m

Foundations

- Order No. 10.58000**
2 items 280 x 40 x 50 cm
Excavation depth 60 cm
- Order No. 10.58100**
2 items 220 x 40 x 50 cm
Excavation depth 60 cm
- Explanation Board
1 item 40 x 40 x 40 cm
Excavation depth 60 cm

Attention:

Exact measurements may vary; for all installation dimensions refer to current assembly instructions.

Technical changes reserved.

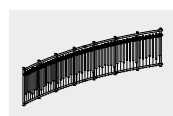

10.58000



10.58100



Photo © Daniel Perales

Play value

Sound behaves in similar ways to water which is why it can be directed through tubes as was done in old ship's telephones. Between two and four speaking/ listening stations can be installed and these are connected by underground pipes and a special sound distributor. It is possible to communicate over unusually long distances without the use of any electronic amplifiers. However, visual contact makes sense.

Recommended for

- Kindergarten children
- School children
- Supervised play areas, such as kindergartens, schools, after-school programmes or similar
- Public play areas without supervision such as playgrounds, parks or similar

Barrier-free

- Independent play



Photo © Daniel Perales



Photo © Anton Donikov



Photo © Daniel Perales

Conference
graubner Play Stations
 for Developing the Senses

Acoustic effect	soft
Vandalism	not vulnerable
Supervision	not necessary
Explanation Board	not necessary
Installation	indoors and outdoors
Safety check (DIN EN 1176)	not necessary
Installation in concrete	not possible



10.55000

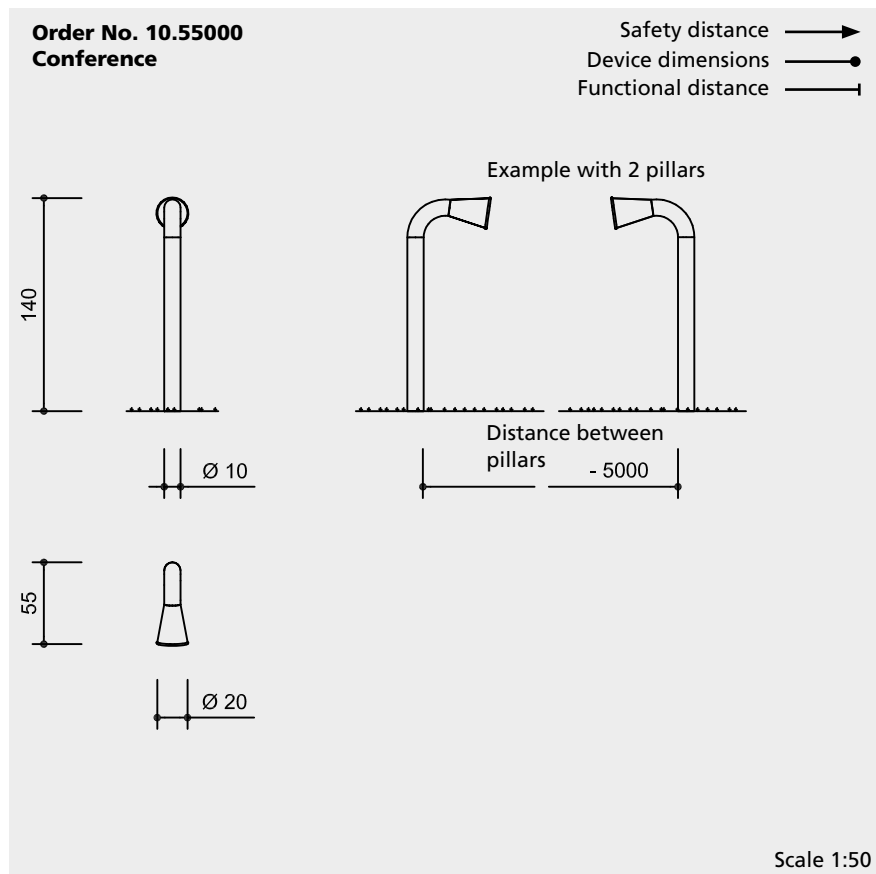

Technical information

Equipment made of stainless steel

Ground anchor

All parts used for anchoring to the ground are made of hot-dip galvanised steel or stainless steel



For more detailed explanation of the quality characteristics see price list.

Cone shaped opening with perforated sheet cover

Dimensions

(small deviations possible)

Height	1.40 m
Tube diameter	0.10 m
Speech and Listening tube	0.20 m
Depth	0.55 m
Weight	21 kg per pillar

Components

Depending on the number ordered
2 - 4 pillars with coupling for dowelling
6 Heavy duty anchors per pillar

Minimum number is 2 pillars

Trademark

30 2005 500 000 Germany
40-0682207 South Korea

On-site work

Supply and installation of the required underground pipes as well as the ducting for connecting materials according to our specifications

Explanation board on request

Installation information

Recommended space
2.00 x 3.00 m per pillar

Foundations
1 item 60 x 60 x 70 cm per pillar
Excavation depth 90 cm

Attention:

Exact measurements may vary; for all installation dimensions refer to current assembly instructions.

Technical changes reserved.



10.55000



Order No. 10.55100 Echo Game with Order No. 10.22500 Rotating Disc, Photo © Daniel Perales

Echo Game
graubner Play Stations
 for Developing the Senses

Play value

Speak into the acoustic cone and listen to the multiple echo. The further the sound travels the more it changes, dark sounds will disappear. The reverberation becomes rhythmical. The echo allows you to experience the limiting effect of space: differing times between echoes give different impressions of space. It is also possible to communicate with each other by speaking into the acoustic cones. Different sound nuances are created depending on where you call into the cone.

Recommended for

- School children
- Young people
- Adults
- Older people
- Public play areas without supervision, such as playgrounds, parks or similar

Barrier-free

- Independent play



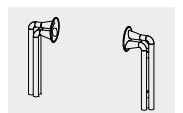

Acoustic effect	soft
Vandalism	not vulnerable
Supervision	not necessary
Explanation Board	included
Installation	outdoors
Safety check (DIN EN 1176)	not necessary
Installation in concrete	not possible



10.55100

Order No. 10.55100
Echo Game

Safety distance 
Device dimensions 
Functional distance 

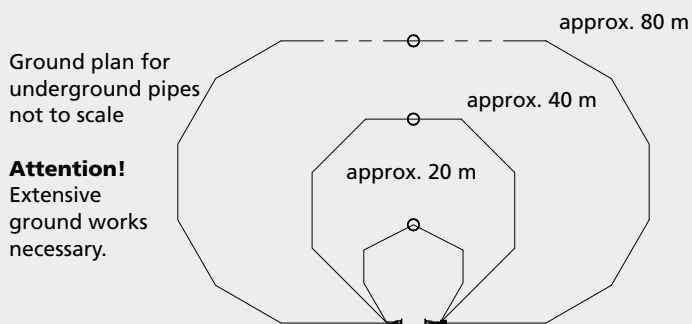
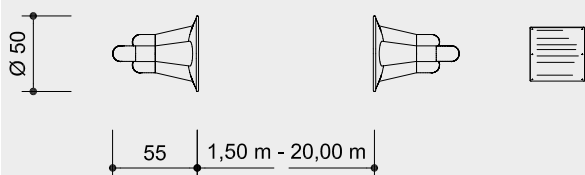
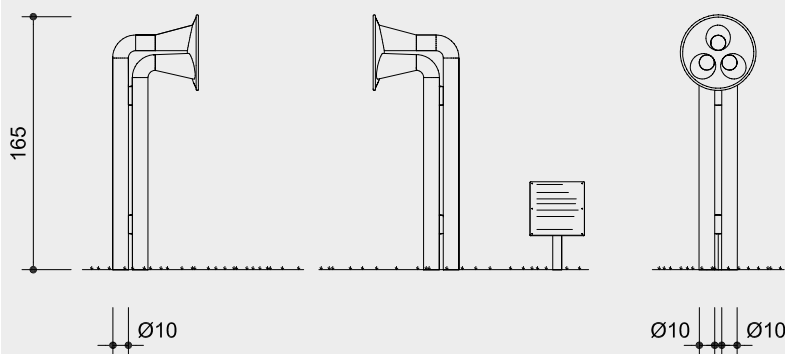

Attention!
Extensive ground works necessary.

Scale 1:50

Technical information

Equipment made of stainless steel

Ground anchor

All parts used for anchoring to the ground are made of hot-dip galvanised steel or stainless steel



For more detailed explanation of the quality characteristics see price list.

Cone shaped openings with incorporated sound reflector and perforated sheet cover

Board and support for Explanation Board made of stainless steel

Dimensions

(small deviations possible)

Height	1.65 m
Tube diameter	0.10 m
Speech and listening tube	0.50 m
Depth	0.55 m
Weight	110 kg

Components

- 2 Echo pillars incl. 14 heavy duty anchors with flange for dowelling and couplings
- 1 Explanation Board with support for dowelling, incl. 4 heavy duty anchors

Trademark

30 2005 500 000 Germany
40-0682207 South Korea

On-site work

supply and installation of the required underground pipes according to our specifications

Installation information

Recommended space
Circle diameter 2.00 m per pillar

- Foundations
- 2 items 80 x 80 x 70 cm
- Excavation depth 90 cm
- Explanation Board
- 1 item 40 x 40 x 40 cm
- Excavation depth 60 cm

Attention:

Exact measurements may vary; for all installation dimensions refer to current assembly instructions.

Technical changes reserved.

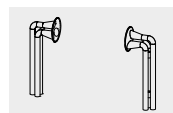

10.55100

**Do you want to know
more about us?**

- ① The main catalogue comprises our complete range of standard equipment.

A selection of our products is described in the following theme catalogues:

- ② For the very Young
- ③ Movement by Climbing
- ④ The Child at Play
- ⑤ Water and Play
- ⑥ Growing Older
- ⑦ Graubner Play Stations for Developing the Senses



Richter Spielgeräte GmbH

Germany · 83 112 Frasdorf · Simsseestraße 29 · Phone + 49 - 80 52 - 1 79 80 · Fax + 49 - 80 52 - 41 80
info@richter-spielgeraete.de · www.richter-spielgeraete.de