

Instructions for wear checks of play equipment

The equipment must be checked for correct operation and safety, especially the points listed below:

Proof of maintenance

Playground

Date of installation

Checks depend on the type of equipment. Any equipment with moving parts must be checked at least twice a year, static equipment at least once a year.

Intervals for maintenance work and checks generally depend on

- location
- kind of use
- frequency of use
- possible vandalism

For more details see also "General instructions for maintenance of playgrounds".

Quadro-Hammock Seat Order No. L6.43500/L6.43600/ K6.43600

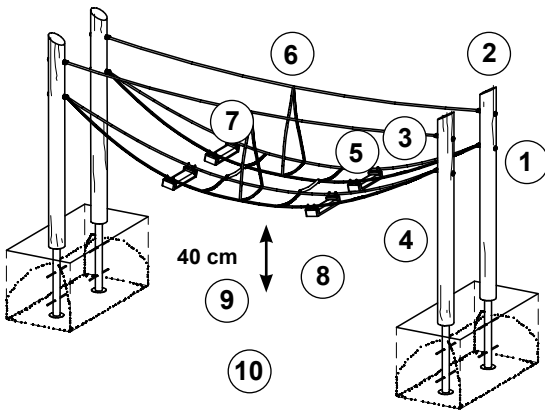

detailed diagram

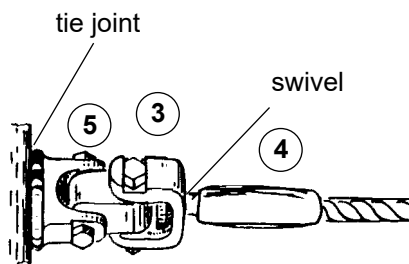

Wooden parts

1. Check for rot and, if necessary, smooth out splinters and round off sharp edges of cracks.
2. **Recommendation:** apply paraffin wax to the upper end grain areas once a year, please refer to Order No. 0.90100, 1 litre.

Joints

3. Check that joints can move smoothly in both directions.
4. Make sure that the swivels move smoothly, apply grease if required.
5. Check connection to wood, tie joint must fit closely (see detailed diagram).

Ropes

6. Check for wear and tear. Replace if steel reinforcement is damaged.
7. Check the connection between the two hammock seats (hose-sleeved chain) for wear and tear, replace connecting element if necessary.

Rubber seats

8. Replace if metal parts are exposed.
9. Check the hammock seats for a ground clearance of 40 cm.

Structural stability

10. In order to check for rot at wooden parts or steel feet for corrosion, uncover the foundations twice a year.

Special notes, e.g. for repairs

Repair not carried out, it is still possible to play on equipment

Repair not carried out, equipment is taken out of action

All work carried out, everything is in order

Maintenance carried out by:

For spare parts refer to back of page.

..... Date

Spare Parts
Quadro-Hammock Seat
Order No. L6.43500
L6.43600/K6.43500

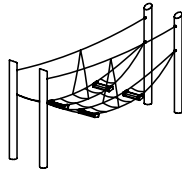

Please note that the safety standards of the equipment must not be affected. Therefore, when carrying out repairs it is helpful to **only use original parts.**

Order No. Spare part

99.01312 rope structure,
 completely swaged,
 without square bar steel

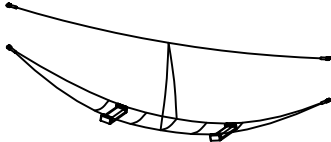

99.01375 Rope structure, nursery version

99.01442 Support post, pre-drilled,
 for steel foot, larch, l=2.45m

99.01458 Support post, pre-drilled,
 Larch incl. steel foot

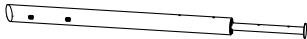

0.88160 Brass bush

0.20010 Machine bolt M 10/8x55
 with locking nut

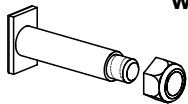

0.88190 Square block bar with 2 brass
 bushes without bolts

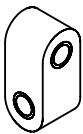

0.92310 Joint for ropes „Herkules“ type



0.93000 Rubber swing seat

