

Instructions for wear checks of play equipment

The equipment must be checked for correct operation and safety, especially the points listed below:

Proof of maintenance

Playground.....

Date of installation

Checks depend on the type of equipment. Any equipment with moving parts must be checked at least twice a year, static equipment at least once a year.

Intervals for maintenance work and checks generally depend on

- location
- usage
- frequency of use
- possible vandalism

For more details see also "General instructions for maintenance of playgrounds".

Toddler's Swing
Order No. 6.12600/L6.12600

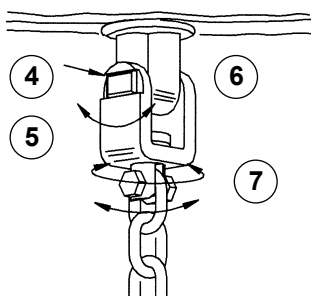
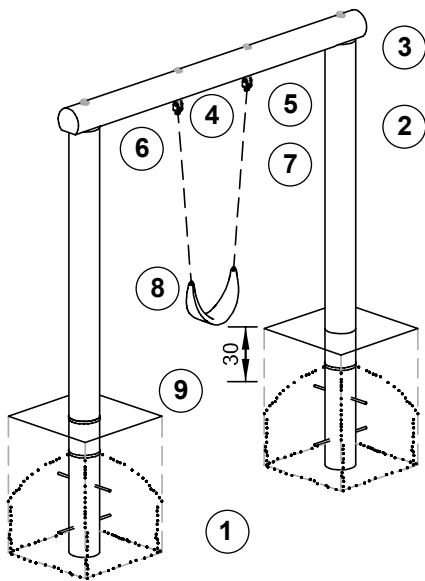

Structural stability

1. Uncover the foundation once a year in order to check for rot or the steel feet for corrosion.

Wooden parts

2. Check for rot and, if necessary, smooth out splinters and round off sharp edges and cracks.
3. Check that all wood connections are tight and retighten if necessary.

Swing suspension

4. Make sure that the joints move smoothly.
5. Make sure that the swivels move smoothly, apply grease if required.
6. Check connection to wood, tie joint must fit closely.
7. Check chain and connection to chain; the first chain link must be locked; check wear on contact surfaces between first and second chain link.

Swing seat

8. Check for vandalism (e.g. cuts) and replace if necessary.
9. Check distance between surfacing and seat; must be at least 30 cm.

Special notes, e.g. for repairs

Repair not carried out, it is still possible to play on equipment

Repair not carried out, equipment is taken out of action

All work carried out, everything is in order

Maintenance carried out by:



For spare parts refer to back of page.

Date

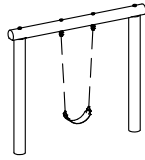
Spare Parts
Toddler's Swing
Order No. 6.12600/L6.12600

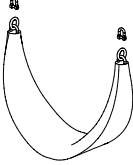
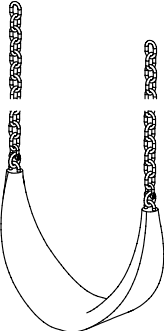
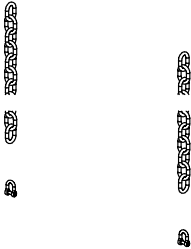

Please note that the safety standards of the equipment must not be affected. Therefore, when carrying out repairs it is helpful to **only use original parts.**

Order No.	Spare part
<p>0.93035</p> 	<p>toddler's belt seat made of rubber with 2 shackles</p>
<p>0.93045</p> 	<p>toddler's belt seat with chains</p>
<p>0.87010</p> 	<p>pair of chains, 6 mm</p>
<p>0.93090</p> 	<p>U-shackle with swivel</p>
<p>0.93130</p> 	<p>swing joint with swivel</p>