

# Instructions for wear checks of play equipment

The equipment must be checked for correct operation and safety, especially the points listed below:

Proof of maintenance

Playground.....

Date of installation .....

Checks depend on the type of equipment. Any equipment with moving parts must be checked at least twice a year, static equipment at least once a year.

Intervals for maintenance work and checks generally depend on

- the location
- the usage
- the frequency of use
- possible vandalism

For more details see also "General instructions for maintenance of playgrounds".

**Cross-scales**  
Order No. L6.10100

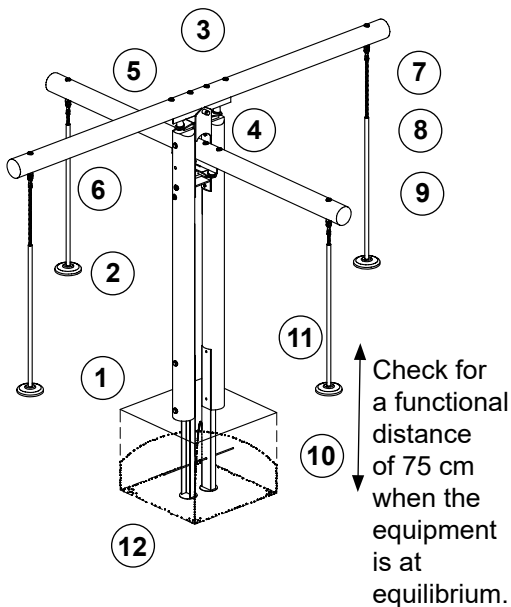

## Wooden parts

1. Check for rot and, if necessary, smooth out splinters and round off sharp edges of cracks.
2. Check that all bolts/screws and all connections are tight and retighten if necessary.
3. **Recommendation:** apply paraffin wax to the upper end grain areas once a year, please refer to order No. 0.90100, 1 litre.

## Scale mechanism

4. Replace rubber buffer if worn down to less than 7 cm of original material height (new 10 cm).
5. Check connection to wood for stability.
6. Grease main bearing at the top part of the rocker beam mechanism (lubricating nipple).

## Pendulum seat suspension

7. Check that the joint can move smoothly in both directions.
8. Check connection to wood, bearing plate must fit closely.
9. Check chain and connection to chain; the first chain link must be locked; check wear on contact surfaces between first and second chain link.
10. Replace pendulum seats if metal parts are exposed.
11. Check hose sleeve fixation, replace sleeve hose, if damaged.

## Structural stability

12. Uncover the foundation once a year in order to check for rot or the steel feet for corrosion.

Special notes, e.g. for repairs

Repair not carried out, it is still possible to play on equipment

Repair not carried out, equipment is taken out of action

All work carried out, everything is in order

Maintenance carried out by:

For spare parts refer to page 3.

..... Date .....

## Additional notes

### Maintenance of one post equipment

This product is a one post equipment according to EN 1176-1.

Equipment of this kind requires special diligence with regard to planning, construction and maintenance.

In this document, you will find additional maintenance notes.

#### **The following principles generally apply to one post equipment:**

The longer the equipment has been in operation, the more diligence is required during maintenance.

Dynamic loads additionally stress the structural stability.

Frequency of use and a given excessive load must be taken into account when scheduling maintenance.

The goal of any inspection must be to ensure that the equipment can be safely used until the next check is due.

It is important to pay attention to the following special aspects for safe operation of one post equipment during regular inspections:

- Check the structural stability **twice a year**, uncover the foundations to do this
- Examine the earth/air zone of stand posts with extra care
- Measures for ensuring structural stability of load-bearing wooden components
  - knocking test: the clearer the sound the "healthier" the wood
  - hammer and nail test: the clearer the sound becomes as the nail is hammered in deeper and deeper, the "healthier" the wood
  - incremental drill test (spot-related information): provides very reliable information on the "internal" condition of the cross-section of the wood in one spot by enabling the person conducting the test to visually check the specimen, rub it between their fingers and smell on it
  - resistograph (spot-related information): very good information on the internal solidity of the wood, however, only experienced experts are able to interpret the measurement graphs
  - tensile test: load test resulting in highly relevant safety-related information (see separate instructions)

#### **Permadrur system as an additional measure for strengthening the structural stability**

Wooden stand posts protected by the Permadrur system (i.e. the part buried in the ground is protected by a black heat-shrink tube and metal foil) are checked in almost the same manner.



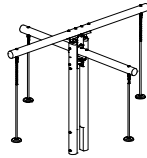

A 500 g hammer with a polyamide head (soft-faced hammer) is used to tap the post. Thus, the heat-shrink tube will not be damaged.

If the post is checked by determining the drill resistance (e. g. resistograph), drilling through the heat-shrink tube and metal foil is possible. However, the drill hole must be sealed with a dowel afterwards.

**Spare Parts**  
**Cross-scales**  
**Order No. L6.10100**

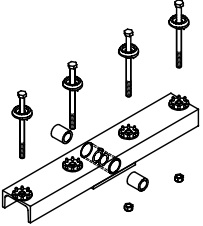
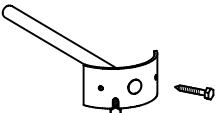
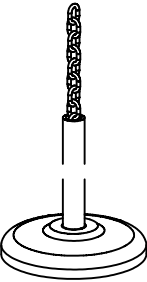
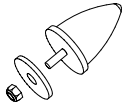
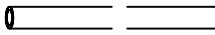
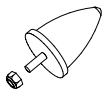

Please note that the safety standards of the equipment must not be affected. Therefore, when carrying out repairs it is helpful to **only use original parts**.

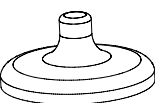
Order No. Spare part	Order No. Spare part
<p>0.92330 joint for pendulum seat</p> 	<p>0.94070 rocker beam mechanism (top part)</p> 
<p>0.95000 pendulum seat with suspension (short) chain length 1.50 m since 12/11</p>	<p>0.94040 axle for scale mechanism Version from 01/95</p> 
<p>0.94135 pendulum seat with suspension (long) chain length 1.95 m since 12/11</p> 	<p>0.94015 parabolic buffer for cross beam (top) with washer</p> 
<p>0.94140 hose sleeve for chain length 1.40 m</p> 	<p>0.94016 parabolic buffer for cross beam (bottom)</p> 
<p>0.92404 chain without fastening length up to 1.50 m since 12/11</p>	<p>0.88110 brass bush for axle Ø 25 mm</p> 
<p>0.92402 chain without fastening length up to 1.95 m since 12/11</p>	<p>0.88190 square block steel with 2 brass bushes</p> 
	
<p>0.94110 pendulum seat without disc</p> 	
<p>0.94120 pendulum seat disc</p> 