

# Instructions for wear checks of play equipment

The equipment must be checked for correct operation and safety, especially the points listed below:

Proof of maintenance

Playground.....

Date of installation .....

Checks depend on the type of equipment. Any equipment with moving parts must be checked at least twice a year, static equipment at least once a year.

Intervals for maintenance work and checks generally depend on

- the location
- the usage
- the frequency of use
- possible vandalism

For more details see also "General instructions for maintenance of playgrounds".

**High Swing long**  
as attachment to Platforms  
**Order No. 3.19850**

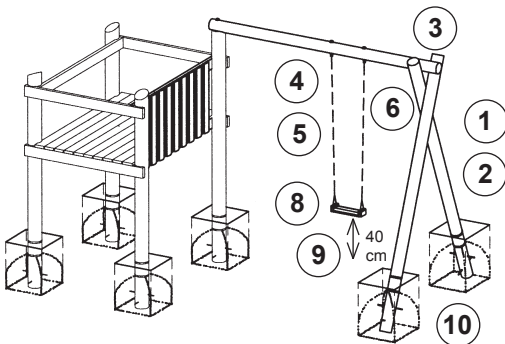

## Wooden parts

1. Check for rot and, if necessary, smooth out splinters and round off sharp edges of cracks.
2. Check that all wooden connections are tight and retighten if necessary.
3. Recommendation: apply paraffin wax to the upper end grain areas once a year, please refer to Order No. 0.90100 (1 litre).

## Swing suspension

4. Make sure that the joints move smoothly.
5. Make sure that the swivels move smoothly, apply grease if required.
6. Check connection to wood, tie joint must fit closely.
7. Check chain and connections to chain, the first chain link must be locked; check wear on contact surfaces between first and second chain link.

## Swing seat

8. Replace swing seat if metal parts are exposed.
9. Check the seat for a minimum ground clearance of 40 cm.

## Structural stability

10. In order to check for rot at wooden parts, uncover the foundation once a year.

Repair not carried out, it is still possible to play on equipment

Repair not carried out, equipment is taken out of action

All work carried out, everything is in order

Maintenance carried out by:

For spare parts refer to back of page.



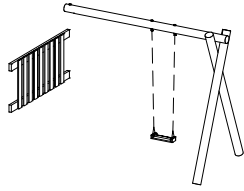

..... Date .....

Special notes, e.g. for repairs

**Spare Parts**  
**High Swing long**  
**Order No. 3.19850**

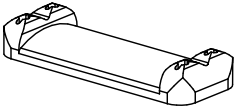
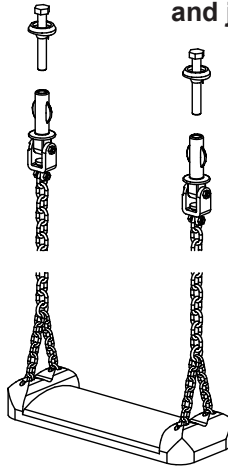
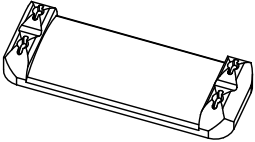

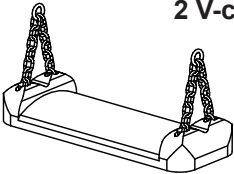
Please note that the safety standards of the equipment must not be affected. Therefore, when carrying out repairs it is helpful to **only use original parts**.

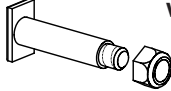
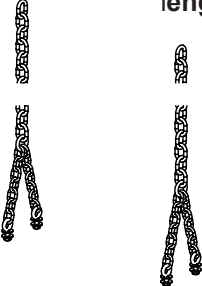
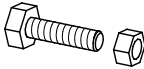
Order No. Spare part	Order No. Spare part
<p><b>0.93000</b> rubber swing seat</p> 	<p><b>0.93120</b> rubber swing seat with chains and joints</p> 
<p><b>0.93010</b> rubber swing seat with 4 eyebolts</p> 	<p><b>0.93090</b> U-shackle with swivel</p> 
<p><b>0.93020</b> rubber swing seat with 2 V-chains</p> 	<p><b>0.88150</b> brass bush for swing joint</p> 
<p><b>0.93021</b> V-chain</p> 	<p><b>0.20010</b> stainless steel machine bolt M8x55 with locking nut</p> 
<p><b>0.93100</b> pair of chains, 6 mm length 2.35 m</p> 	<p><b>0.20020</b> stainless steel machine bolt M8x28 with locking nut</p> 
<p><b>0.93110</b> rubber swing seat with chains</p> 